

- D** Elektroanlage für Anhängervorrichtung Montage- und Betriebsanleitung, Originalbetriebsanleitung
- CZ** Elektrické zařizení pro tažné zařizení Montážní a provozní návod
- DK** Elsæt til anhængertræk Montage- og driftsvejledning
- E** Instalación eléctrica para el dispositivo de remolque Instrucciones de montaje y de servicio
- F** Installation électrique pour dispositif d'attelage Notice de montage et d'utilisation
- FIN** Vetolaitteen sähköjärjestelmä Asennus- ja käyttöohjeet
- GB** Electrical system for trailer hitch Installation and Operating Instructions
- GR** Ηλεκτρικό σύστημα για διάταξη ρυμούλκησης Οδηγίες συναρμολόγησης και λειτουργίας
- H** Elektromos felszerelés a vonószerkezet Beszerelési utasítás
- I** Impianto elettrico per gancio di traino Istruzioni di montaggio e per l'uso
- N** Elektrisk anlegg for tilhengerfeste Monterings- og bruksanvisning
- NL** Elektrische installaties voor aanhanger Montage- en gebruikshandleiding
- PL** Instalacja elektryczna do haka holowniczego Instrukcja montażu i eksploatacji
- RUS** Электрооборудование для фаркопа Инструкция по монтажу и эксплуатации
- S** Elsystem för dragkrok Monterings- och bruksanvisning

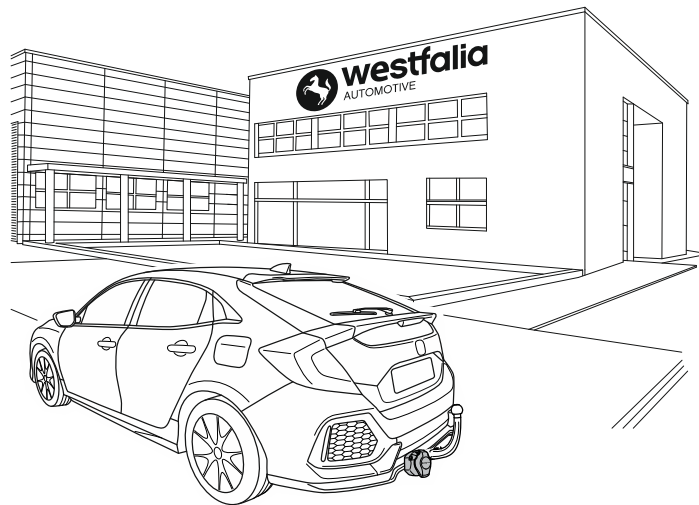

**338 145 300 107**

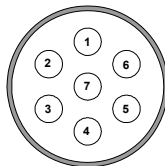

**338 145 300 113**

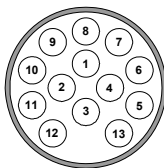

**Honda Civic, 2017 →**

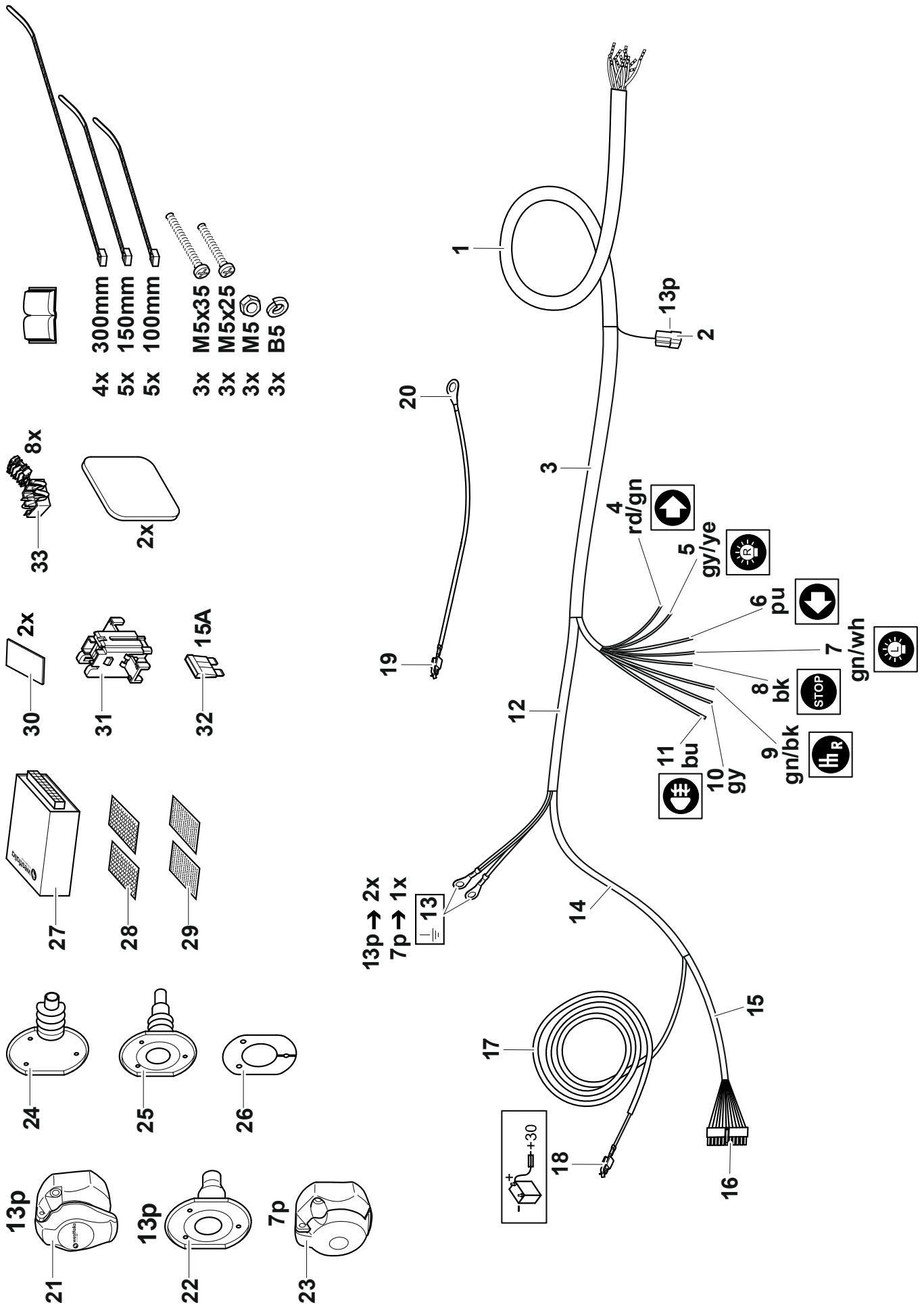

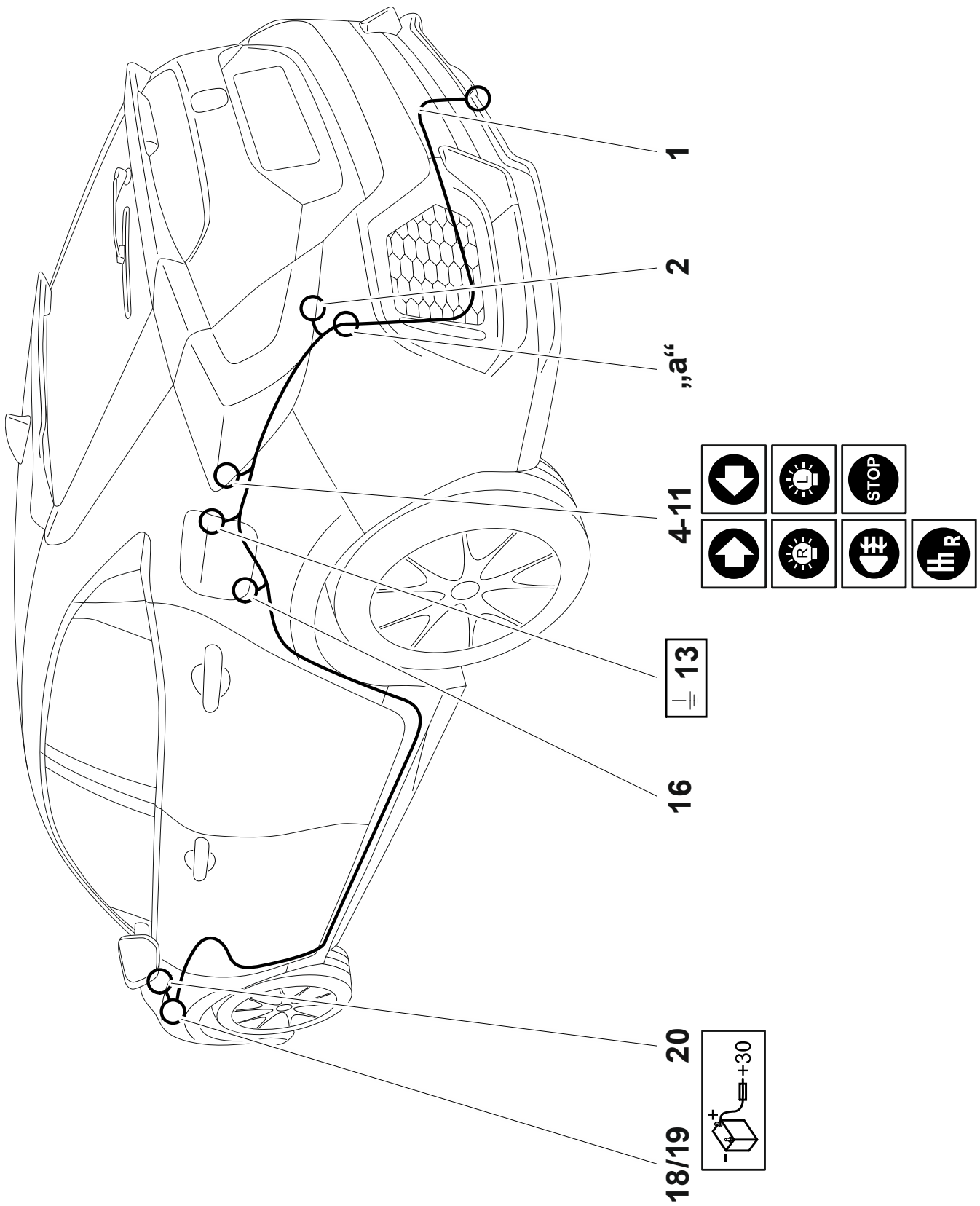







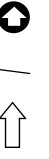



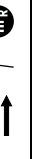

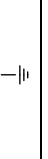



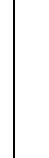





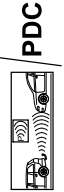
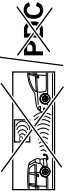

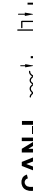
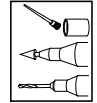



- |           |                                     |            |                                    |            |                          |
|-----------|-------------------------------------|------------|------------------------------------|------------|--------------------------|
| <b>D</b>  | Steckdosenbelegung                  | <b>CZ</b>  | Obsazení zásuvky                   | <b>DK</b>  | Koblingskema             |
| <b>E</b>  | Esquema de tomas de enchufe         | <b>F</b>   | Affectation des prises électriques | <b>FIN</b> | Pistorasian navat        |
| <b>GB</b> | Pin assignment                      | <b>GR</b>  | Αντιστοιχία πρίζας                 | <b>H</b>   | Csatlakozódugó leosztása |
| <b>I</b>  | Schema dei collegamenti della presa | <b>N</b>   | Kontaktksjema                      | <b>NL</b>  | Contactdoosbezetting     |
| <b>PL</b> | Rozkład pinów                       | <b>RUS</b> | Разводка розеток                   | <b>S</b>   | Stickdosschema           |

		ISO 11446																	
		<b>S</b>	<b>RUS</b>	<b>PL</b>	<b>NL</b>	<b>N</b>	<b>I</b>	<b>H</b>	<b>GR</b>	<b>GB</b>	<b>FIN</b>	<b>F</b>	<b>E</b>	<b>DK</b>	<b>CZ</b>	<b>D</b>	Leistung / Power		
			svart/ vit	vit	brun	svart/ hvit	nero/ bianco	fekete/fehér	μαύρο/ λευκό	black/ white	musta/valkoinen	noir/ blanc	negro/ blanco	sort/hvid	černobílá	schwarz/ weiß	21 W	1 (L)	
			svart/ vit	vit	brun	svart/ hvit	nero/ bianco	fekete/fehér	μαύρο/ λευκό	black/ white	musta/valkoinen	noir/ blanc	negro/ blanco	sort/hvid	černobílá	schwarz/ weiß	Min. 21 W Max. 42 W	2 (54g)	
			brun	brązowo	bruin	brun	marrone	barna	καφέ	brown	ruskea	marron	marrón	brun	hnědá	braun		3 (31)	
			svart/ grön	svart/ zelený	svart/ groen	svart/ grønn	nero/ verde	fekete/zöld	μαύρο/ πράσινο	black/ green	musta/vihreä	noir/vert	negro/ verde	sort/grøn	černo/ zelená	schwarz/ grün	21 W	4 (R)	
			grå/ röd	szary/ czerwony	grijs/ rood	grå/rød	grigio/ rosso	szürke/piros	μαύρο/ κόκκινο	gray/ red	harmaa/ punainen	gris/ rouge	gris/rojo	grå/rød	šedo/ červená	grau/rot		5 (58R)	
			svart/ röd	svart/ czerwony	svart/ rood	svart/ rød	nero/ rosso	fekete/piros	μαύρο/ κόκκινο	black/ red	musta/punainen	noir/ rouge	negro/ rojo	sort/rød	černo/ červená	schwarz/ rot		6 (54)	
			grå/ svart	szary/ czarny	grijs/ zwart	grå/ svart	grigio/ nero	szürke/feket	μαύρο	gray/ black	harmaa/ musta	gris/ noir	gris/ negro	grå/sort	šedočerná	grau/schwarz		7 (58L)	
			grön	zelený	groen	grønn	verde	zöld	πράσινο	Green	vihreä	vert	verde	grøn	zelená	grün		8	
			röd	czerwony	rood	rød	rosso	piros	κόκκινο	red	punainen	rouge	rojo	røjo	červená	rot		9 (+30)	
			--	--	--	--	--	--	--	--	--	--	--	--	--	--		10 (+15)	
			--	--	--	--	--	--	--	--	--	--	--	--	--	--		11 (31)	
			--	--	--	--	--	--	--	--	--	--	--	--	--	--		12	
			brun/ svart	коричне вый/ черны	brązowo/ czarno	bruin/ zwart	brun/ svart	marrone/ nero	barma/ fekete	καφέ/ μαύρο	brown/ black	ruskea/ musta	marron/ noir	marrón/ negro	brun/ sort	hnědá/ černo	braun/ schwarz		13 (31)

	dark	light	bk	wh	bn	gn	gy	rd	ye	bu	or	pu	pi
<b>D</b>	dunkel	hell	schwarz	weiß	braun	grün	grau	rot	gelb	blau	orange	violett	rosa
<b>CZ</b>	tmový	bystrý	černo	bílá	hnědá	zelená	šedo	červená	žlutá	modrý	oranžový	fialový	růžová
<b>DK</b>	mørk	lyse	sort	hvid	brun	grøn	grå	rød	gul	blå	orange	violet	rosa
<b>E</b>	oscuro	claro	negro	blanco	marrón	verde	gris	rojo	amarillo	azul	anaranja-do	violeta	rosa
<b>F</b>	foncé	clair	noir	blanc	marron	vert	gris	rouge	jaune	bleu	orange	violet	rose
<b>FIN</b>	tumma	kirkas	musta	valkoinen	ruskea	vihreä	harmaa	punainen	keltainen	sininen	oranssi	violetti	rosa
<b>GB</b>	dark	light	black	white	brown	green	grey	red	yellow	blue	orange	purple	pink
<b>GR</b>	σκούρο	φωτεινό	μαύρο	λευκό	καφέ	πράσινο	γκρι	κόκκινο	κίτρινο	μπλε	πορτοκαλί	Μωβ	ροζ
<b>H</b>	sötét	fényes	fekete	fehér	barna	zöld	szürke	piros	sárga	kék	narancssárga	ibolyakék	rózsaszín
<b>I</b>	scuro	luminoso	nero	bianco	marrone	verde	grigio	rosso	giallo	blu	arancione	viola	rosa
<b>N</b>	mørk	lyse	svart	hvit	brun	grønn	grå	rød	gul	blå	oransje	fiolett	rosa
<b>NL</b>	donkere	heldere	zwart	wit	bruin	groen	grijs	rood	geel	blauw	oranje	violet	rosé
<b>PL</b>	ciemny	jasno	czarno	biały	brązowo	zielony	szaro	czerny	żółty	niebieski	pomarańczowe	fioletowe	różowa
<b>RUS</b>	темно	светло	черный	белый	коричневый	зеленый	серый	красный	желтый	голубой	оранжевый	пурпурный	розовый
<b>S</b>	mörk	ljus	svart	vit	brun	grön	grå	röd	gul	blå	orange	violett	rosa

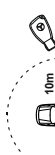
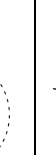
																																																																																																																																																																																																																																																																																																																																																										
---	---	---	---	---	---	---	---	---	---	---	---	---	---	---	---	---	---	---	---	---	---	---	---	---	---	---	---	---	---	---	---	---	---	---	---	---	---	---	---	---	---	---	---	---	---	---	---	---	---	---	---	---	---	---	---	---	---	---	---	---	---	---	---	---	---	---	---	---	---	---	---	---	---	---	---	---	---	--	--	--	--	--	--	--	--	--	--	--	--	--	--	--	--	--	--	--	--	--	--	--	--	--	--	--	--	--	--	--	--	--	--	--	--	--	--	--	--	--	--	--	--	--	--	--	--	--	--	--	--	--	--	--	--	--	--	--	--	--	--	--	--	--	--	--	--	--	--	--	--	--	--	--	--	--	--	--	--	--	--	--	--	--	--	--	--	--	--	--	--	--	--	--	--	--	--	--	--	--	--	--	--	--	--	--	--	--	--	--	--	--	--	--	--	--	--	--	--	--	--	--	--	--	--	--	--	--	--	--	--	--	--	--	--	--	--	--	--	--	--	--	--	--	--	--	--	--	--	--	--	--	--	--	--	--	--	--	--	--	--	--	--	--	--	--	--	--	--	--	--	--	--	--	--	--	--	--	--	--	--	--	--	--	--	--	--	--	--	--	--	--	--	--	--	--	--	--	--	--	--	--	--	--	--	--	--	--	--	--	--	--	--	--	--	--	--	--	--	--	--	--	--	--	--	--	--	--	--	--	--	--	--	--	--	--	--	--	--	--	--	--	--	--	--	--	--	--	--	--	--	--	--	--	--	--	--	--	--	--	--	--	--	--	--	--	--	--

	D	CZ	DK	E	F	FIN	GB	GR	H	I	N	NL	PL	RUS	S
	keine Feuchtigkeit	Žádná vlhkost	Ingen fugtighed	No hay humedad	Pas d'humidité	ei kosteutta	no lubrication	όχι υγρασία	nedvességet	assenza di umidità	ingen fuktighet	Geen vocht	Brak wilgoci	Нет жидкости	ingen fukt
	LED Prüflampe	Zkušební LED svítlna	LED testlampe	Lámpara de prueba de LED	Lampe de contrôle à diode	LED tarkastuslamppu	LED test lamp	Λυχνία ελέγχου LED	LED ellenőrző lámpa	Luce di verifica LED	LED testlampe	LED control-lampje	Lampka kontrolna LED	Светодиодная контрольная лампа	LED kontrolllampa
	Rechtslenker	Pravostranné řízení	Højrestyret	con dirección a la derecha	Direction à droite	Ohjaua oikealla puolella	right-hand drive vehicle	Δεξιότροπο	jobb kormány	Guida a destra	Ratt på høyre side	Stuur rechts	Kierownica z prawej strony	Автомобиль с правосторонним расположением рулевого управления	Högerstyrt fordon
	Linkslenker	Levostranné řízení	Venstrestyret	con dirección a la izquierda	Direction à gauche	Ohjaua vasemmalla puolella	left-hand drive vehicle	Αριστερότροπο	balkormány	Guida a sinistra	Ratt på venstre side	Stuur links	Kierownica z lewej strony	Автомобиль с левосторонним расположением рулевого управления	Vänsterstyrt fordon
	mit Einparkhilfe	S parkovací asistent	Med parkeringshjelp	con asistencia de estacionamiento	Avec aide au stationnement	Pysäköintipuu	with parking aid	Με σύστημα παρακαρπάριατος	beparkolási támogatással	con ausilio al parcheggio	med parkeringsassistent	Met parkeer-sensor	z asystentem parkowania	С парковочным радаром	med parkeringshjelp
	ohne Einparkhilfe	Bez parkovací asistentia	Uden parkeringshjelp	sin asistencia de estacionamiento	Sans aide stationnement	Ei pysäköintipuu	without parking aid	Χωρίς σύστημα παρακαρπάριατος	beparkolás nélkül	senza ausilio al parcheggio	uten parkeringsassistent	Zonder parkeer-sensor	bez asystenta parkowania	Без парковочного радара	utan parkeringshjelp
	Datenbusleitung (CAN)	Datový kabel sběrnice CAN	Databusledning (CAN)	Cable de bus de données (CAN)	Câble de bus de données (CAN)	Tietoväylä (CAN)	data bus cable (CAN)	Αγωγός διαύλου δεδομένων (CAN)	adatsbus vezeték (CAN)	Linea bus dati (CAN)	Databusledning (CAN)	Przewód magistrali danych (CAN)	Датабусовідлення (CAN)	Сигнал CAN High	CAN High Signal
	CAN High Signal	Vysokovýštní sběrnice CAN	CAN High signal	Señal CAN High	Signal CAN haut	CAN - signaali korkealla	CAN high signal	Σήμα CAN High	CAN High jel	Segnale CAN High	CAN High-signal	CAN High Signal	CAN High Signal	Сигнал CAN High	CAN High Signal
	CAN Low Signal	Nizkovýštní sběrnice CAN	CAN Low signal	Señal CAN Low	Signal CAN faible	CAN - signaali matalalla	CAN low signal	Σήμα CAN Low	CAN Low jel	Segnale CAN Low	CAN Low-signal	CAN Low Signal	CAN Low Signal	Сигнал CAN Low	CAN Low Signal
	Karosseriebohren und versiegeln	Vyvrátí díru do karosérie a následně ji zapraví	Bor og forsegl karosserihulversiegel	Perforar agujero de carrocería y sellarlo	Perçage et masticage des trous de carrosserie	Kori, poraa reikä ja tiivistä	drill and seal bodywork hole	Διτρυφή και σφραγισμός οπής στο αμάξωμα	lyuk fúrás a karossziarás és lezárás	Trapanare e sigillare i fori carrozzeria	Bore og forsegl hull i karosseriet	Carosserie-gat boren en verzegelen	Wykonać otwór w karoserii i zabezpieczyć.	Просверлить и запечатать отверстие в кузове	Borra och forsegl karosshål
	Klebeband	Lepicí páska	Tape	Cinta adhesiva	Ruban adhésif	Liimanauha	adhesive tape	Κολλητική ταινία	ragasztószalag	Nastro adesivo	Limbånd	Kleefband	Tasma klejaca	Клейкая лента	Tejp
	Radio Codierung beachten	Pozor na kód rádia	Bemærk radio kodning	Tener en cuenta código radio	Attention à la codification radio	Huomaa radio-koodaus	observe radio coding	Προσοχή στην συμπιαστική κωδικοποίηση	rádió kódolására figyelni	Rispettare codifica radio	Vær oppmerksom på radiokodning	Radio-codering in acht nemen	Uwzględnić kodowanie radia	Учитывать кодировку радио	Observera radiokodning
	Achtung! Säure	Pozor! Kyseliny	OBS! Syre	¡Atención! Ácido	Attention ! Acide	Huomio! Happoa	Warning! acid	Προσοχή! Οξύ	Figyelem! Sav	Attenzione! Acido	Obs! Syre	Opgelet! Zuren	Uwaga! kwas	Внимание! Кислота	Observera Syra

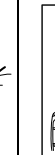
											
<b>D</b>	Zigarettenanzünder, 12V Steckdose	Fahrzeugkabelfarbe / grammiergerät	Funktion Kabelfarbe ausmessen / vergleichen	abweichende Kabelfarbe notieren	Funkschlüssel / Chipcard 10m vom Fahrzeug entfernen!	Taster im Fahrzeug vorhanden ja / nein	verbinden	trennen	Signalgeber	beachten / erkennen	Signal Anhänger erkannt
<b>CZ</b>	Zapalovač, 12V zásuvka	Test vozidla / programova cí zařizení	Zjistit/porovnat barvu kabelu	Zaznamenať odlišnou barvu kabelu	Vzdálit se s dálkovým ovládním nebo čipovou kartou 10 m od vozidla	Tlačítko jehnení k dispozici ve vozidle	Spojít	Rozpojit	Upozornění	Prohlédnout /zhodnotit	Rozpoznání signálu přívěsu
<b>DK</b>	Cigaret tænder, 12V stikkåse	Køretøj Test/programmiering senhed	Funktion kabelfarve ud mål/sammenlign	Notér afvigende kabelfarve	Trådløs nøgle / chipcard 10 m væk fra køretøjet!	Finder der en knapp i køretøjet ja / nej	tilslut	adskil	Signalgiver	bemærk / registrere	Signal anhænger registreret
<b>E</b>	Encendedor de cigarrillos, enchufe de 12V	Appareil de prueba/programación de vehículo	Función Medir/comparar color de cable	Anotar color de cable diferente	Alejar llave inalámbrica / Chipcard 10m del vehículo!	Existe pulsador en el vehículo sí / no	unir	separar	Emisor de señales	observar / reconocer	Señal remolque detectada
<b>F</b>	Prise allume-cigares 12V	Appareil de programmation ation/contrôle du véhicule	Mesurer/comparer couleur de câble de fonction.	Noter différence de couleur câble	Eloigner de 10 m du véhicule la clé de radiocommande	Touche dans le véhicule oui / non	connecter	séparer	Avertisseur	observer / identifier	Signal remorque identifié
<b>FIN</b>	Savukkeensytyin, 12V-pistoke	Ajoneuvo-testi/ohjelmointilaitte	Kaapelivärin toimitto, mittaa ja vertaa	Merkitse poikkeava kaapeliväri muistiin	Vie radioaivain / sirukortti 10 m päähan ajoneuvosta	Painike ajoneuvossa kyllä/ei	yhdistä	erota	Merkintalaitte	huomaa/tunnista	Perävaunun signaali tunnistettu
<b>GB</b>	cigarette lighter, 12V socket	vehicle test/programming equipment	measure / compare function cable colour	note different cable colours	remove remote key / chipcard to 10m away from the vehicle	switch available in vehicle yes / no	connect	disconnect	signal transmitter	observe / recognize	trailer signal recognized
<b>GR</b>	Ανατρίψος, τριπλή 12V	Συσκευή δοκιμής/πρωτοτύπου οχήματος	Λειτουργία μέτρησης/σύνθεσης/σύγκρισης χρώματος καλωδίων	Επισημάνω αποκλίσεις χρώματος καλωδίου	Απομακρύνετε το κλειδί της τηλεχειρισιμής κάρτας / τσιπ 10 m από το όχημα!	Υπάρχει πλήκτρο στο όχημα ναι/όχι	Συνδέση	Αποσύνδεση	Κωδικοποιητής σήματος	Παρατήρη / αναγνώριση	Αναγνώριση σήματος ρυμουγκού έσου
<b>H</b>	szivagyújtó, 12V-os dugalj	járműteszt/programozó készülék	kábelszín mérési / összehasonlító funkció	eltérő kábelszín feljegyzése	A rádiófrekvenciás kulcsot / tny csipkártyát a járműről 10m-re eltávolítani!	Nyomógomb a járműben igen/nem	összekapcsolás	szétválasztás	jeladó	figyelembe venni / felismerni	Ujántű jel felismerve
<b>I</b>	Accendisigari, presa da 12 V	Dispositivo di test/programmazione veicolo	Misurare / confrontare funzione colore cavo	Annotare colore cavo divergente	Allontanare a 10 m dal chipcard la chiave con telecomando o la scheda chip!	Tasto presente nel veicolo sì / no	collegare	scollegare	Indicatore di segnale	rispettare / riconoscere	Segnale rimorchio riconosciuto
<b>N</b>	Sigarettenne, 12 V stikkontakt	Kjøretøy test/programmeringsenheter	Måle / sammenlign funksjon kabelfarge	noter avvikende kabelfarge	Radio-nøkkel / Chipcard 10 m unna kjøretøyet!	Knapp finnes i kjøretøyet ja / nei	koble til	koble fra	Signalgiver	overhold / registrer	Signal tilhenger registrert
<b>NL</b>	Sigarettenaansteker, 12V stopcontact	Voertuig-test/programmeringsapparaat	Funcitie kabelkleur uitmeten / vergelijken	Afwijkende kabelkleur noteren	Draadloze sleutel / Chipcard 10m van het voertuig verwijderen!	Knop in het voertuig aanwezig ja / nee	Verbinden	Onderbreken	Signaalgever	Opmerken / herkennen	Signaal aanhangwagen herkend
<b>PL</b>	Zapalniczka, gniazdko 12V	Test pojazdu/luz. program.	Funkcja pomiaru/por. kolorów kabli	zauważać różniące się kolory	Klucz zdalny/karta chipowa odległość pojazdu maks. 10 m!	Przycisk dostępny w pojeździe tak / nie	połączyć	rozłączyć	Nadajnik sygnału	uwzględnić/rozpoznać	Signal przyczeprzozpoznany
<b>RUS</b>	Прикуриватель, розетка 12 В	Устройство тестирования / программа ования автомобиля	Измерить / сравнить функцию окраски кабеля	Записать отклонение окраски кабеля	Радиоключ / использовать чиповую карту на расстоянии 10 м от автомобиля	Контактный щуп в автомобиле да / нет	Соединить	Разделить	Разделитель	Датчики сигналов	Сигнал прицепа распознан
<b>S</b>	Cigaretändare, 12 V uttag	Fordon test/programeringsdon	Funktion kabelfärg mäta upp/jämför	Notera avvikande kabelfärg	Trådlös nyckel/avlägsna chipcard 10 m från fordonet	Knapp finns i fordonet Ja/Nej	Anslut	Frånskilj	Signalgivare	Observera/id entifiera	Signal släpvragn identifierad



**D**

Nationale Richtlinien über die Anbauabnahmen sind zu beachten.

Jegliche Änderungen bzw. Umbauten an der Elektroanlage sind verboten. Sie führen zum Erlöschen der Betriebserlaubnis. Vor Arbeitsbeginn die Einbauanleitung lesen.

Wichtig: Prüfen Sie den Inhalt des Sets, bevor Sie mit der Installation beginnen und melden Sie gegebenenfalls Abweichungen. Beginnen Sie erst mit der Installation, wenn Sie über ein vollständiges Set verfügen.

Die Elektroanlage für Anhängervorrichtung darf nur von Fachunternehmen montiert werden. Bei falscher Montage besteht schwere Unfallgefahr!

Westfalia-Automotive haftet nicht für Personen- oder Sachschäden beziehungsweise Verluste, die durch die Installation oder eine fehlerhafte Montage oder Nutzung des Produkts verursacht werden.

Arbeiten an Airbags dürfen nur von entsprechend geschultem Personal durchgeführt werden.

Achtung – vor Arbeitsbeginn den Fehlerspeicher auslesen, ggf. Ruhestrom-Erhaltungsgerät verwenden, ansonsten können elektronisch gespeicherten Daten verloren gehen. Batterie abklemmen, um Beschädigungen der KFZ- Elektronik zu vermeiden.

Für technische Änderungen, Software updates, die nach Erst- Inbetriebnahme z.B. durch den Fahrzeughersteller durchgeführt werden und zu Fehlfunktionen bei Anhängerbetrieb führen, kann keine Gewährleistung übernommen werden.

Leitungen dürfen weder eingeklemmt noch beschädigt sein. Alle Dichtungselemente ordnungsgemäß anbringen.

Bei Anhängerbetrieb wird die Nebelschlussleuchte des Zugfahrzeugs abgeschaltet.

Ein Steckdosenadapter darf nur im Anhängerbetrieb genutzt werden.

- Der Ausfall der Anhängerblinkleuchten wird durch ein akustisches Signal gemeldet.

Die Prüfung der Anhängerfunktionen mit einem Anhänger oder einem Prüfgerät mit Belastungswiderständen durchführen.

Achtung! Es ist sicherzustellen das alle Anforderungen des Fahrzeughersteller zu Änderungen und Nachrüstungen am Fahrzeug und/oder Kühlsystem für den Betrieb mit Anhänger durchgeführt wurden.

Bitte beachten: Mit diesem E-Satz werden bei Anhängerbetrieb die fahrzeugseitigen Assistenzsysteme nicht beeinflusst oder verändert.

**Der deutsche Text dieser Anleitung ist bindend.**

Änderungen vorbehalten.

**CZ**

Je nutné dodržovat místní směrnice o demontáži nástaveb.

Veškeré změny příp. přestavby elektrického zařízení jsou zakázány. Mají za následek zánik platnosti povolení k provozu.

Před zahájením práce si prostudujte návod k montáži.

Důležité: Před montáží zkontrolujte obsah soupravy a nahláste případné odlišnosti. S montáží začněte pouze v případě, že máte k dispozici kompletní soupravu.

Elektrické zařízení pro tažné zařízení smí montovat pouze odborné podniky. Při chybné montáži hrozí vážné nebezpečí nehody! Společnost Westfalia-Automotive není zodpovědná za případná zranění, škody na majetku nebo ztráty na zisku, které mohou být způsobeny chybnou montáží nebo nesprávném používáním výrobku.

Práce na airbagů by měl provádět pouze řádně vyškolení pracovníci.

Pozor – před zahájením práce načtěte paměť chyb, popř. použijte zařízení pro udržení klidového proudu, jinak můžete ztratit elektronicky uložená data. Odpojte akumulátorovou baterii, aby nedošlo k poškození elektronické soustavy vozidla.

Neneseme žádnou zodpovědnost za technické změny a aktualizace softwaru provedené po prvním uvedení do provozu (např. výrobcem vozidla), které mohou způsobit nesprávnou funkci přívěsu.

Vodiče nesmí být sevřené ani poškozené. Všechny těsnicí prvky náležitě namontujte.

Při provozu s tažným zařízením se vypne koncové světlo do mlhy na tažném vozidle.

Adaptér zásuvky se smí používat jen při provozu s přívěsem.

- Výpadek směrových světel přívěsu je ohlášen akustickým signálem.

Kontrolu funkcí přívěsu provádějte pomocí přívěsu nebo vhodného kontrolního přístroje se zatěžovacími odpory.

Pozor! Ujistěte se, zda jsou splněny všechny podmínky provozu přívěsu stanovené výrobcem vozidla a zda byly provedeny všechny úpravy a dodatečné vybavení vozidla či chladicího systému.

Vezměte prosím na vědomí: Tato e-nastavení palubní asistenčních systémů nejsou ovlivněny nebo změněny při jízdě s přívěsem.

**Německý text tohoto návodu je závazný.**

Změny vyhrazeny.

**DK**

De nationale direktiver for montering af tilbehør skal overholdes.

Enhver ændring eller ombygning på el-anlægget er forbudt. Dette medfører, at typegodkendelsen ikke er gældende.

Læs monteringsvejledningen inden påbegyndelse af arbejdet.

Vigtigt: Kontrollér sættets indhold inden du begynder med installationen og meddel i givet fald afvigelser. Begynd først installationen, når du har et komplet sæt.

Elsættet til anhængertrækket må kun monteres af kvalificeret personel. Ved forkert montering er der fare for alvorlige fejlfunktioner!

Westfalia-Automotive overtaget ikke ansvaret for person- eller tingskader henholdsvis for tab, der er forårsaget af en forkert installation, montage eller anvendelse af produktet.

Arbejdet med airbags bør kun udføres af dertil uddannet personale.

Bemærk – udlæs fejlloggen inden påbegyndelse af arbejdet, anvend evt. apparat til opretholdelse af hvilestrøm, ellers kan elektronisk lagrede data gå tabt. Frakobl batteriet for at undgå beskadigelse af personbilens elektronik.

For tekniske ændringer, software-updates, der gennemføres efter den første ibrugtagning, f.eks. af køretøjsproducenten og som medfører fejlfunktioner i anhængerdriften, kan der ikke overtages noget ansvar.

Ledningerne må ikke hverken blive klemt eller beskadiget. Alle tætningsselementerne skal anbringes efter forskrifterne.

Ved brug af anhængerens elastik frakobles trækkøretøjets tågebaglygte.

En stikdåseadapter må udelukkende anvendes ved drift med anhængerens.

- Hvis anhængerblinklysene er defekte, angives det på denne måde: Der lyder et akustisk signal.

Kontrol af anhængerfunktionerne skal foretages med en anhænger eller et kontrolapparat med belastningsmodstand.

OBS! Kontrollér, at alle køretøjsproducentens krav til ændringer og eftermonteringer på køretøj og/eller kølesystem til brug med anhænger er blevet gennemført.

Bemærk: denne e-indstille indbyggede hjælpesystemer er ikke berørt eller ændres ved kørsel med anhænger.

**Den tyske tekst i denne vejledning er bindende.**

Ret til ændringer forbeholdes.

**E**

Deben respetarse las directivas nacionales referentes a controles de enganches.

Está prohibido modificar o remodelar la instalación eléctrica. La consecuencia sería la invalidación del permiso de circulación. Antes de iniciar la tarea, lea las instrucciones de montaje.

Importante: Verifique el contenido del juego antes de comenzar con la instalación y notifique las diferencias si las hubiera. Comience con la instalación recién cuando disponga de un juego completo.

La instalación eléctrica para el dispositivo de remolque sólo debe montarla personal cualificado. ¡En caso de montaje erróneo existe peligro de accidentes graves!

Westfalia-Automotive no asume ninguna responsabilidad por daños personales o materiales, respectivamente pérdidas, que sean causados por la instalación o por un montaje o uso del producto deficientes.

Trabajo sobre las bolsas de aire sólo debe ser realizada por personal debidamente capacitado.

Atención – antes de iniciar la tarea, leer la memoria de fallos, si es necesario utilizar un dispositivo de mantenimiento de corriente de reposo, de lo contrario podría perder los datos memorizados electrónicamente. Desconecte la batería para evitar daños en la instalación eléctrica del vehículo.

No puede asumirse ninguna garantía por modificaciones técnicas o actualizaciones de software que hayan sido realizadas después de la primera puesta en servicio, p. ej. por el fabricante del vehículo, y que causen funcionamientos defectuosos en la operación del remolque.

Se debe evitar dañar o aprisionar los cables. Instalar correctamente todas las juntas.

Al circular con remolque se desconecta la luz antiniebla trasera del vehículo de tiro.

Sólo se puede usar un adaptador de caja de enchufe cuando se circule con remolque.

- Si se funde alguno de los intermitentes del remolque, ello se indicará mediante Una señal acústica.

La comprobación de las funciones del remolque debe efectuarse con un remolque o bien con un equipo de comprobación con resistores reguladores de carga.

¡Atención! Se debe asegurar que se ha cumplido con todos los requerimientos del fabricante del vehículo en lo que respecta a modificaciones y reequipamiento en el vehículo y/o sistema de refrigeración para la operación con remolque.

Tenga en cuenta: este e-establecen los sistemas de asistencia a bordo no se ven afectados o se cambian de un remolque.

**Es vinculante el texto alemán de estas instrucciones.**

Nos reservamos el derecho a efectuar modificaciones.

**F**

Les dispositions nationales concernant la réception à titre isolé doivent être respectées.

Toute modification ou transformation de l'installation électrique est interdite. Elle entraînerait l'annulation de la réception.

Lire impérativement la notice de montage avant de commencer le travail.

Important : Vérifier le contenu de l'ensemble avant de commencer l'installation et mentionner le cas échéant les anomalies. Ne commencer l'installation que lorsque vous disposez d'un ensemble complet.

Seules des entreprises spécialisées sont autorisées à monter le faisceau électrique du dispositif d'attelage. Un montage incorrect représente un risque élevé d'accident !

Westfalia-Automotive n'est pas tenu responsable des dommages aux personnes ou matériels ou bien de pertes qui seraient causés par l'installation ou un montage défectueux ou une mauvaise utilisation du produit.

Travail sur les airbags ne doivent être effectuées que par du personnel formé.

Attention – Avant de commencer le travail, éliminer l'ensemble des défauts présents dans la mémoire de l'ordinateur de bord ou utiliser un générateur de courant de veille pour éviter que des données enregistrées sur support électroniques ne soient perdues. Débrancher la batterie afin d'éviter tout endommagement de l'installation électronique du véhicule.

Aucune garantie ne peut être prise en charge eu égard aux modifications techniques, aux mises à jours de logiciel qui sont effectuées après la première mise en marche, par ex. : par le fabricant du véhicule et qui conduisent à des fonctionnements défectueux de la remorque.

Les fils électriques ne doivent être ni endommagés ni coincés. Mettre en place tous les éléments d'étanchéité conformément à la notice.

Lorsqu'une remorque/caravane est attelée, le fonctionnement du feu de brouillard arrière du véhicule tracteur est interrompu.

Un adaptateur pour prise de courant ne doit être utilisé que si une remorque/caravane est tractée.

- La défaillance des clignotants de la remorque est signalée par un signal acoustique.

Le contrôle des fonctions de l'attelage doit s'effectuer avec une remorque ou avec un appareil de contrôle muni d'ampoules classiques.

Attention ! Il convient de s'assurer que toutes les consignes imposées du fabricant du véhicule ont été respectées concernant les modifications et les équipements ultérieurs réalisés sur le véhicule et/ou le système de refroidissement pour l'utilisation avec la remorque.

S'il vous plaît noter: Cet e-définir les systèmes d'assistance à bord ne sont pas affectés ou modifiés en tractant une remorque.

**Le texte allemand de cette notice fait foi.**

Sous réserve de modifications.

Kansallisia suuntaviivoja, mitä tulee asennukseen, on noudatettava.

Kaikki sähköjärjestelmään tehtävät muutokset tai jälkiasennukset ovat kiellettyjä. Nämä johtavat käyttöluvan raukeamiseen. Lue asennusohjeet ennen työskentelyn aloittamista.

Tärkeää: Tarkasta sarjan sisältö, ennen kuin aloitat asennuksen ja ilmoita mahdollisista poikkeamista. Aloita asennus vasta, kun olet varma, että sarja on täydellinen.

Vetolaitteen sähköjärjestelmän saa asentaa vain alan erikoisliike. Virheellinen asennus voi aiheuttaa vakavan onnettomuuden! Westfalia-Automotive ei vastaa henkilö- tai esinevahingoista tai muistakaan vahingoista, jotka ovat seurausta tuotteen virheellisestä asennuksesta tai käytöstä.

Työ turvatuynyt saa suorittaa vain asianmukaisesti koulutettu henkilöstö.

Huomio: lue vikamuisti ennen työskentelyn aloittamista. Käytä tarvittaessa lepovirran säilymistä varmistavaa laitetta, jotta elektronisesti tallentuneet tiedot eivät katoa muistista. Irrota akun navat, jotta ajoneuvon elektroniikka ei vaurioidu.

Valmistaja ei vastaa teknisistä muutoksista tai ohjelmistopäivityksistä, jotka toteutetaan ensimmäisen käyttöönoton jälkeen tai ajoneuvon valmistajan toimesta ja joista on seurauksena perävaunun käyttöön virhetoimintoja.

Johdot eivät saa jäädä puristuksiin eivätkä vaurioitua. Kiinnitä kaikki tiiviste-elementit asianmukaisesti.

Vetoajoneuvon takasumivalot eivät toimi vetolaitteen käytön aikana.

Pistorasia-adapteria saa käyttää ainoastaan perävaunun yhteydessä.

- Perävaunun suuntavilkkujen vioittumisesta ilmoittaa äänimerkki.

Perävaunuun liittyvät toiminnot on testattava joko perävaunun kanssa tai kuormitusvastuksilla varustetulla testauslaitteella.

Huomio! On varmistettava, että kaikkia ajoneuvon valmistajan ajoneuvoon ja/tai jäähdytysjärjestelmään tehtäviin muutoksiin ja jälkivarusteluihin, jotka koskevat perävaunun käyttöä, liittyviä vaatimuksia noudatetaan.

Huomaa: tämä e-set laivalla avustinjärjestelmä ei vaikuta tai muuttaa perävaunua vedettäessä.

**Tämän ohjeen saksankielinen teksti on sitova.**

Oikeudet muutoksiin pidätetään.

Observe national guidelines on the approval of accessories.

Any alteration or modification of the electrical system is prohibited and voids the operating licence.

Read the installation manual before beginning to work.

Important: Check contents of kit before commencing installation and report any discrepancies. Do not commence installation unless you have a complete kit.

Only qualified companies may install the electrical system for the trailer hitch. Improper assembly may result in a serious accident hazard!

Westfalia-Automotive is not liable for personal injury, damage or loss caused by the installation or improper assembly or use of the product.

Work on airbags should only be performed by properly trained personnel.

Attention – before starting to work, read out the errors stored in the memory. If required, use a power supply to prevent electronically saved data from being erased. Disconnect the battery to prevent damage to the vehicle electronics.

No guarantee can be given for the malfunctioning of the trailer operation caused by technical changes, software updates, carried out by the vehicle manufacturer, for example, after the initial commissioning.

Verify that no cables are squeezed or damaged. Properly install all seals.

When towing a trailer, the rear fog light of the pulling vehicle is switched off.

An electrical socket adapter may only be used when towing a trailer.

- A failure of the trailer turn signal lamps is indicated by an acoustic signal.

Check the trailer functions with a trailer or a testing instrument with load resistors.

Warning! It must be ensured that all the requirements of the vehicle manufacturer for changes to and retro-fitting on the vehicle and / or cooling system for the operation with a trailer are carried out.

Please note: this e-set do not affect or change the onboard assistance systems when towing a trailer.

**The German text of this instruction is binding.**

Subject to change.

Πρέπει να τηρούνται οι κρατικοί κανονισμοί σχετικά με τον έλεγχο προσθηκών στα αμαξώματα.

Απαγορεύονται οι αλλαγές και οι μετατροπές στην ηλεκτρική εγκατάσταση. Συναπτάγονται την ακύρωση της άδειας λειτουργίας.

Πριν από την έναρξη των εργασιών μελετήστε τις οδηγίες τοποθέτησης.

Σημαντικό: Ελέγξτε το περιεχόμενο του σετ προτού αρχίσετε τις εργασίες εγκατάστασης, και αναφέρετε τυχόν αποκλίσεις. Αρχίστε την εγκατάσταση μόνο εφόσον το σετ που διαθέτετε είναι πλήρες.

Το ηλεκτρικό σύστημα για διατάξεις ρυμούλκησης επιτρέπεται να τοποθετείται μόνο από ειδικά συνεργεία. Σε περίπτωση λάθους τοποθέτησης υπάρχει κίνδυνος σοβαρών ατυχημάτων!

Η Westfalia-Automotive δεν φέρει ευθύνη για τραυματισμούς, ζημιές ή απώλειες που προκαλούνται από την εγκατάσταση ή από τυχόν εσφαλμένη τοποθέτηση ή χρήση του προϊόντος.

Οι εργασίες σχετικά με τους αερόσακους θα πρέπει να εκτελείται μόνο από κατάλληλα εκπαιδευμένο προσωπικό.

Προσοχή – Πριν από την έναρξη των εργασιών διαβάστε τη μνήμη σφαλμάτων ή αντίστοιχα χρησιμοποιήστε μία συσκευή διατήρησης ρεύματος. Διαφορετικά μπορεί να χαθούν τα ηλεκτρικά αποθηκευμένα δεδομένα. Αποσυνδέστε την μπαταρία ώστε να αποφευχθούν οι ζημιές στα ηλεκτρονικά του οχήματος.

Για τεχνικές αλλαγές και ενημερώσεις λογισμικού μετά την πρώτη θέση σε λειτουργία που εκτελούνται π.χ. από τον κατασκευαστή του οχήματος και οδηγούν σε σφάλματα λειτουργίας του συστήματος ρυμούλκησης, δεν αναλαμβάνεται ευθύνη.

Τα καλώδια δεν πρέπει ούτε να μαγκώνονται ούτε να είναι χαλασμένα. Τοποθετήστε σωστά όλα τα στοιχεία στεγανοποίησης.

Κατά την οδήγηση με τρέιλερ το πίσω φανάρι ομίχλης του έλκοντος οχήματος απενεργοποιείται.

Ένας προσαρμογέας πρίζας επιτρέπεται να χρησιμοποιηθεί μόνο κατά την οδήγηση με τρέιλερ.

- Σε περίπτωση βλάβης των φώτων φλας της ρυμούλκας εκπέμπεται ένα ακουστικό σήμα.

Ο έλεγχος των λειτουργιών της ρυμούλκας πρέπει να γίνεται ή με μία ρυμούλκα ή με μια συσκευή μετρήσεων με αντιστάσεις καταπόνησης.

Προσοχή! Θα πρέπει να διασφαλιστεί ότι έχουν υλοποιηθεί όλες οι απαιτήσεις του κατασκευαστή του οχήματος για μετατροπές και προσθήκες εξοπλισμού στο όχημα ή/και το σύστημα ψύξης, οι οποίες σχετίζονται με τη λειτουργία με ρυμούλκούμενο.

Παρακαλώ σημειώστε: Αυτό το ηλεκτρονικό ρυθμίστε τα συστήματα επί του σκάφους βοήθειας δεν επηρεάζονται ή να αλλάξει κατά τη ρυμούλκηση τρέιλερ.

**Το γερμανικό κείμενο αυτών των οδηγιών είναι δεσμευτικό.**

Διατηρούμε το δικαίωμα αλλαγών.

**H**

Figyelembe kell venni a műszaki átvételre vonatkozó nemzeti irányelveket.

Az elektromos felszerelésen tilos bármiféle átalakítást végezni. A szerkezet megváltoztatása vagy átalakítása a forgalmi engedély megszűnését vonja maga után.

A munka megkezdése előtt olvassa el a szerelési útmutatót.

Fontos: A beépítés megkezdése előtt ellenőrizze a garnitúra tartalmát és adott esetben jelentse az eltéréseket. Csak akkor kezdje meg a beépítést, ha teljes garnitúra rendelkezésére áll.

A vonószerkezet elektromos részét csak szaküzem szerelheti be. Helytelen szerelés súlyos balesethez vezethet!

A Westfalia-Automotive nem vállal felelősséget a beépítés vagy hibás szerelés vagy a termék használata által okozott személyi sérülésekért vagy dologi károkért.

Végzett munka légszákok csak akkor kell elvégezni a megfelelően képzett személyzet.

Figyelem– a munka megkezdése előtt olvassa ki a hibatárolót, adott esetben használjon nyugalmi áramot fenntartó készüléket, máskülönben elveszhetnek az elektronikusan tárolt adatok. Kösse le az akkumulátort, hogy megelőzze a gépjármű elektronikájának megrongálódását.

Az első üzembe helyezés után pl. a járműgyártó által elvégzett és az utánfutó hibás működéséhez vezető műszaki változtatásokért, szoftverfrissítésekért jótállás nem vállalható.

A vezetékek nem lehetnek becsípődve vagy megrongálódva. Minden szigetelő elemet a rendeltetésének megfelelően szereljen.

Utánfutóüzemben ki lesz kapcsolva a vontatójármű hátsó ködlámpája.

Dugóaljzat adaptert csak vontatóüzemben szabad használni.

- Az utánfutó indexlámpáinak kiesését egy akusztikus hang jelzi.

Ellenőrizze az utánfutó funkciók működését egy utánfutóval vagy egy terhelő ellenállásokkal ellátott ellenőrzőkészülékkel.

Figyelem! Biztosítani kell, hogy a járműgyártónak az utánfutóval történő működtetés érdekében a járművön és/vagy a hűtőrendszeren elvégzendő változtatásokra vonatkozó minden követelménye teljesüljön.

Megjegyzés: Ez az e-set a fedélzeti rendszerek pedig nem érintett, vagy megváltozott utánfutó vontatása esetén.

**A német szerelési utasítás betartása kötelező.**

Változtatások jogát fenntartjuk.

**I**

Devono essere osservate le normative nazionali sui collaudi.

È vietato modificare o montare diversamente l'impianto elettrico. Ciò comporta l'annullamento del permesso di circolazione.

Prima di iniziare i lavori, leggere le istruzioni di montaggio.

Importante: Controllare il contenuto del kit, prima di iniziare l'installazione e segnalare eventuali divergenze. Iniziare l'installazione soltanto quando il kit di cui si dispone è completo.

L'impianto elettrico per il gancio di traino deve essere montato solo da personale specializzato. In caso di montaggio errato sussiste il pericolo di incidenti gravi!

Westfalia-Automotive non è responsabile per danni a cose o persone o nello specifico di perdite verificatesi in seguito all'installazione, al montaggio o all'uso difettoso del prodotto.

Il lavoro sul airbag deve essere eseguita solo da personale addestrato.

Attenzione – prima di iniziare i lavori, leggere la memoria errori, se necessario utilizzare un dispositivo di mantenimento della corrente di riposo per non perdere i dati memorizzati. Scollegare la batteria al fine di evitare danni all'impianto elettronico del veicolo.

Non si assume responsabilità alcuna per modifiche tecniche e aggiornamenti software che vengono effettuati dopo la prima messa in funzione dal costruttore del veicolo e che possono provocare il funzionamento difettoso del rimorchio.

I cavi non devono essere schiacciati né danneggiati. Installare correttamente gli elementi di tenuta.

Durante il funzionamento con rimorchio la luce antinebbia posteriore della motrice viene spenta.

Utilizzare un adattatore per prese esclusivamente per il funzionamento con rimorchio.

- Un eventuale guasto degli indicatori di direzione del rimorchio viene segnalato da: Un segnale acustico.

Il controllo delle funzioni del rimorchio deve essere eseguito con un rimorchio o con un apparecchio di controllo con resistenza di carico.

Attenzione! Occorre controllare che vengano rispettati tutti i requisiti del costruttore del veicolo relativi alle modifiche e agli accessori sul veicolo e/o sull'impianto del raffreddamento per l'esercizio del rimorchio.

Attenzione: questo e-impostare i sistemi di assistenza a bordo non sono interessati o modificati quando si traina un rimorchio.

**È vincolante il testo tedesco di queste istruzioni.**

Con riserva di modifiche.

**N**

Nasjonale retningslinjer om godkjenning av monteringer skal overholdes.

Enhver endring hhv. ombygging av det elektriske anlegget er forbudt. Dette vil ødelegge brukeropplevelsen.

Les montasjeveiledningen før man begynner arbeidet.

Viktig: Kontroller innholdet i settet før du starter installasjonen og meld fra om eventuelle avvik. Start installasjonen først når du har et fullstendig sett.

Det elektriske anlegget til tilhengerfestet må kun monteres av fagbedrift. Det er stor fare for at det kan oppstå ulykker ved feil montering!

Westfalia-Automotive er ikke ansvarlig for personskader eller materielle skader hhv. tap som skyldes installasjon eller feil montering eller bruk av produktet.

Arbeid på kollisjonsputer bør kun utføres av personell med tilstrekkelig opplæring.

OBS – før arbeidet starter må man lese av feilminnet hhv. benytte hvilestrøms-måleapparat for å unngå at elektronisk lagrede data går tapt. Koble fra batteriet for å unngå at kjøretøyelektronikken skades.

Det blir ikke gitt noen garanti for tekniske endringer, programvareoppdateringer som utføres etter første igangkjøring f.eks. av kjøretøyprodusenten, og som fører til funksjonsfeil ved bruk av tilhengeren.

Ledninger må verken klemmes fast eller skades. Alle tettningsselementer må monteres på plass i riktig posisjon.

Ved bruk av tilhenger blir baklysene til trekkvognen koblet ut.

Stikkontaktadapteret må kun brukes i kombinasjon med tilhenger.

- Ved svikt i tilhengerblinklys: meldes det fra med et akustisk signal.

Kontrollen av tilhengerfunksjonen foretas med en tilhenger eller et kontrollinstrument med belastningsmotstander.

Obs! Man må forsikre seg om at alle kravene til kjøretøyprodusenten vedrørende endringer og etterutrustninger på kjøretøyet og/eller kjølesystemet ble gjennomført for drift med tilhenger.

Vennligst merk: Denne e-set ombord assistentsystemer er ikke berørt eller endret ved kjøring med tilhenger.

**Den tyske teksten i denne veiledningen er bindende.**

Med forbehold om endringer.

**NL**

Nationale richtlijnen betreffende de montagegoedkeuring moeten in acht worden genomen.

Elke wijziging van de elektrische installatie is verboden. Wijziging leidt tot verval van de gebruikstoestemming.

Voor montage eerst de inbouwhandleiding lezen.

Belangrijk: controleer de inhoud van de set voor u met de installatie begint en meld eventuele afwijkingen. Begin pas met de installatie wanneer u over een volledige set beschikt.

De elektrische installatie voor aanhanger mag alleen door vakkundig personeel worden gemonteerd. Bij verkeerde montage bestaat ernstig gevaar voor ongevallen!

Westfalia-Automotive kan niet verantwoordelijk worden gesteld voor materiële schade, lichamelijke letsels of voor mogelijk verlies dat door de installatie, foutieve montage of verkeerd gebruik van het product werd veroorzaakt.

Werkzaamheden aan airbags mag alleen worden uitgevoerd door goed opgeleid personeel.

Attentie – voor montage het foutgeheugen aflezen, eventueel ruststroomapparaat gebruiken, anders kunnen elektrisch opgeslagen gegevens verloren gaan. Los de accu klemmen om beschadiging van de voertuigelektroniek te vermijden.

Voor technische wijzigingen, software-updates die na de eerste ingebruikneming (bijv. door de fabrikant van het voertuig) worden uitgevoerd en bij het gebruik van de aanhangwagen tot storingen leiden, kan Westfalia niet verantwoordelijk worden gesteld.

Leidingen mogen niet klemmen of beschadigd zijn. Alle afdichtelementen volgens voorschrift aanbrengen.

Bij gebruik van de aanhanger wordt het mistachterlicht van het voertuig uitgeschakeld.

Een contactdoosadapter mag uitsluitend bij het rijden met aanhangwagen worden gebruikt.

- De uitval van de aanhangerknipperlichten wordt door een akoestisch signaal gemeld.

De controle van de aanhangerfuncties met een aanhanger of een testapparaat met belastingsweerstand uitvoeren.

Opgelet! Zorg ervoor dat voor de werking met aanhangwagen aan alle eisen van de voertuigfabrikant i.v.m. veranderingen en wijzigingen aan het voertuig en/of koelsysteem werd voldaan.

Let op: Dit e-set van de systemen aan boord van hulp worden niet beïnvloed of gewijzigd wanneer een aanhangwagen.

**De Duitse tekst van deze handleiding is bindend.**

Wijzigingen voorbehouden.

**PL**

Proszę przestrzegać krajowych wytycznych dotyczących odbioru technicznego.

Wszelkie zmiany lub przebudowy instalacji elektrycznej są zabronione. Spowodują one utratę ważności świadectwa homologacji.

Przed rozpoczęciem pracy należy przeczytać instrukcję montażu.

Ważne: Sprawdzić zawartość zestawu przed rozpoczęciem instalacji i zgłosić ewentualne odchylenia. Rozpocząć instalację jeżeli zestaw jest kompletny.

Instalacja elektryczna do haka holowniczego może zostać zamontowana wyłącznie przez firmę specjalistyczną. W przypadku nieprawidłowego montażu istnieje poważne ryzyko wypadku!

Firma Westfalia-Automotive nie ponosi odpowiedzialności za obrażenia oraz szkody materialne, wzgl. straty spowodowane instalacją lub nieprawidłowym montażem bądź użytkowaniem produktu.

Prace na poduszki powietrzne powinny być wykonywane wyłącznie przez odpowiednio przeszkolony personel.

Uwaga! Przed rozpoczęciem pracy należy sprawdzić pamięć błędów i w razie potrzeby zastosować urządzenie utrzymujące prąd ciągły. W przeciwnym razie może dojść do utraty danych elektronicznych. Odłączyć akumulator w celu uniknięcia uszkodzeń w instalacji elektrycznej pojazdu.

Nie przejmuje się żadnej odpowiedzialności z tytułu wprowadzania technicznych zmian i aktualizacji oprogramowania, które zostały dokonane np. przez producenta pojazdu od chwili pierwszego uruchomienia i które generują błędy podczas eksploatacji przyczepy.

Przewody nie mogą być zaciśnięte ani uszkodzone. Prawidłowo zamontować wszystkie elementy uszczelniające.

Podczas holowania przyczepy odłączone jest tylne światło przeciwmgielne.

Adapter gniazda może być używany tylko podczas holowania przyczepy.

- Awarię kierunkowskazów przyczepy sygnalizuje: sygnał akustyczny.

Funkcje przyczepy należy sprawdzić z podłączoną przyczepą lub za pomocą przyrządu kontrolnego z opornością obciążenia.

Uwaga! Należy się upewnić, że zostały spełnione wszystkie wymagania producenta pojazdu dotyczące zmian i doposażania pojazdu i/lub systemu chłodzenia w celu eksploatacji z przyczepą.

Uwaga: Ten adres e-Ustaw pokładowe systemy pomocy nie są naruszone lub zmienione podczas holowania przyczepy.

**Tekst niniejszej instrukcji w języku niemieckim jest wiążący.**

Zmiany zastrzeżone.

Подлежат соблюдению национальные директивы о порядке приемки навесного/встраиваемого оборудования. Какие-либо изменения и переделки на электрооборудовании недопустимы. Они делают недействительным разрешение на эксплуатацию.

Перед началом работы прочтите инструкцию по монтажу.

Важно: Проверить содержимое набора перед началом установки и сообщить в случае отклонений. Начинать установку только при наличии полного набора.

К монтажу электрооборудования сцепного устройства допускаются только специализированные фирмы. При неправильном монтаже грозит опасность тяжелых травм!

Westfalia-Automotive не несет ответственности за ущерб, причиненный людям или имуществу, и соотв. за убытки, причиной которых стали ошибки при установке, монтаже или использовании продукта.

Работа над подушками безопасности должны выполняться только надлежащим образом обученным персоналом.

Внимание – перед началом работы прочтите содержимое накопителя сбоев, при необходимости воспользоваться источником бесперебойного питания во избежание потери сохраненных данных в электронных устройствах. Отсоединить батарею, чтобы предотвратить повреждение электроники автомобиля.

Гарантийные претензии не принимаются в случае технических изменений, обновлений ПО, которые были произведены после первичной приемки в эксплуатацию, например, производителем автомобиля и привели к неправильной работе прицепа.

Не допускать заземления и повреждения электропроводки. Все уплотнения устанавливать как положено.

При пользовании прицепом отключать на тягаче заднюю противотуманную фару.

Пользоваться розеточным переходником только при работе с прицепом.

- Выход из строя фонарей указателей поворота для прицепа сопровождается звуковым сигналом.

Проверку работы прицепа вести с самим прицепом или пробником с нагрузочными сопротивлениями.

Внимание! Необходимо удостовериться, что выполнены все требования производителя автомобиля по изменениям и дополнительному оснащению автомобиля и/или системы охлаждения для эксплуатации с прицепом.

Пожалуйста, обратите внимание: этот адрес электронной почты установить системы на борту помощь не влияет или изменены при буксировке прицепа.

**Обязательным является немецкий текст данной инструкции.**

Право на внесение изменений сохраняется.

Nationella riktlinjer beträffande monteringen skall beaktas.

All form av ändring respektive ombyggnad på elsystemet är förbjuden. Förändringar resulterar i att körtillståndet upphör att gälla.

Läs igenom monteringsanvisningarna innan arbetet påbörjas.

Viktigt: Kontrollera setets innehåll innan du börjar med installationen och rapportera i förekommande fall avvikelser. Börja med installationen först när du har ett komplett set.

Elsystemet för dragkroken får endast monteras av kvalificerade tekniker. Vid felaktig montering föreligger risk för allvarliga olyckor!

Westfalia-Automotive tar inte ansvar för personskador eller materiella skador resp. förluster, som förorsakats av installationen eller en felaktig montering eller användning av produkten.

Arbete på krockkuddar bör endast utföras av utbildad personal.

Obs – innan arbetet påbörjas, läs av felminnet och använd vid behov enheten för bibehållning av vilostrom, annars kan elektroniskt sparade data gå förlorade. Frånkoppla batteriet för att undvika skador på fordonselektroniken.

Ingen garanti ges för tekniska ändringar, programuppdateringar, som genomförs efter idrifttagningen för första gången, t.ex. av fordonstillverkaren och som leder till felfunktioner vid användningen av släpet.

Ledningarna får inte vara klämda eller skadade. Montera alla tätningselement korrekt.

När släpvagnen är påhängd släcks dragfordonets dimbakljus.

Stickdosadaptern får bara användas i kombination med släpvagn.

- Om blinkersljusen på släpvagnen slutar att fungera indikeras detta med en akustisk larmsignal.

Släpvnagsfunktionerna ska kontrolleras med hjälp av en påhängd släpvagn eller en provningsutrustning med belastningsmotstånd.

Observera! Det skall säkerställas att samtliga krav från fordonstillverkaren gällande ändringar på och kompletteringsutrustning av fordonet och/eller kylsystemet för användning med släp har genomförts.

Observera: Den här e-set ombord assistanssystem påverkas inte eller ändras vid körning med släpvagn.

**Den tyska texten i denna anvisning är bindande.**

Ändringar förbehålls.

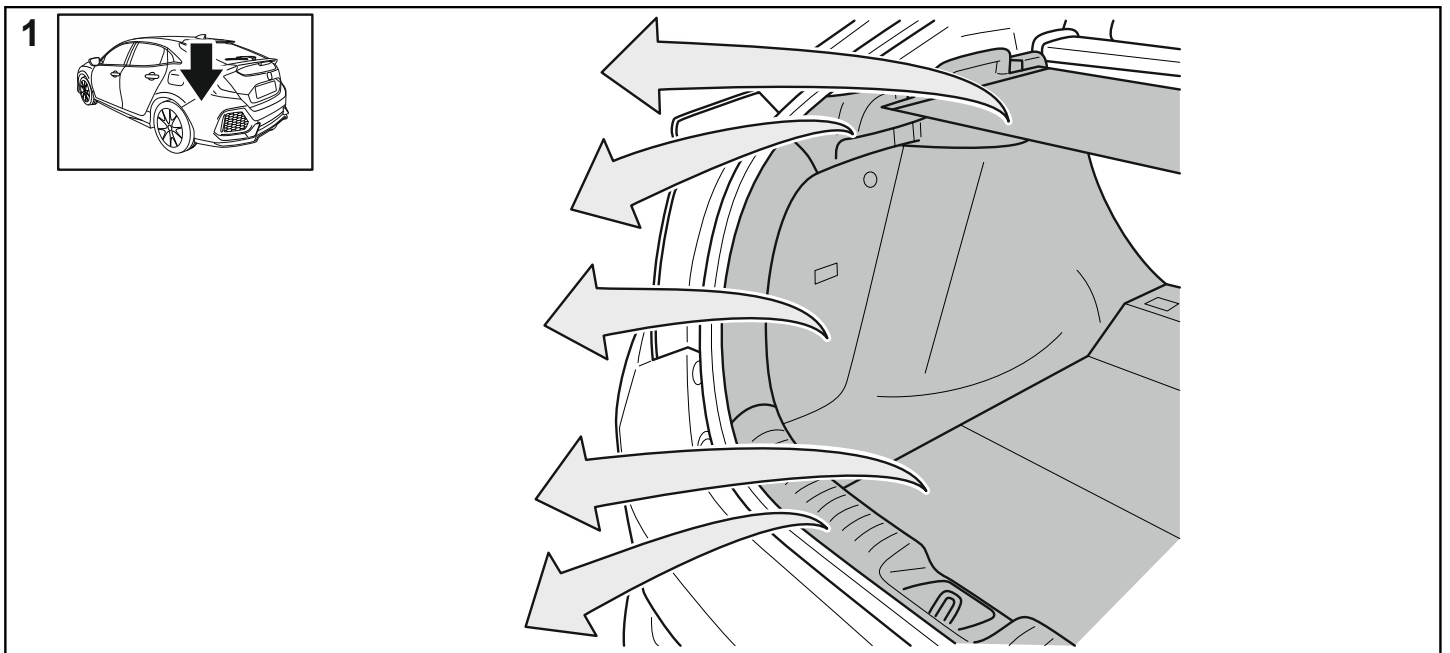
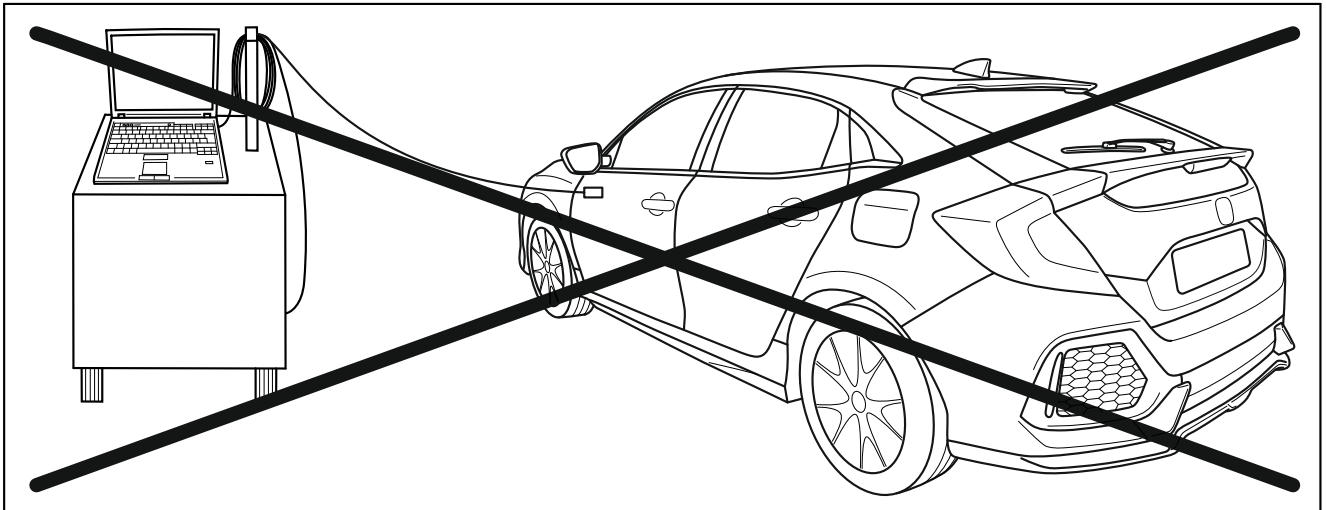
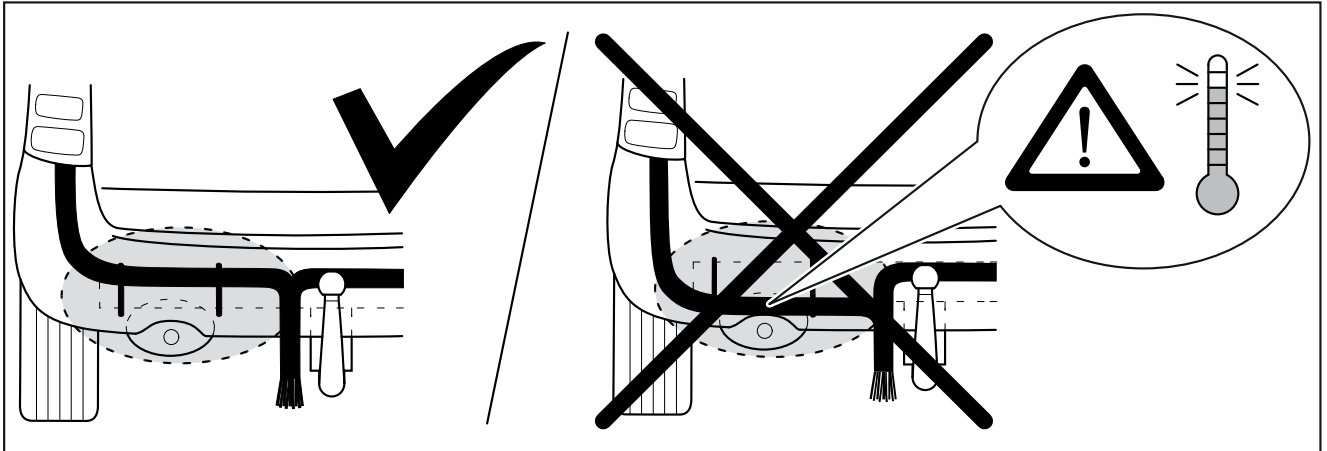
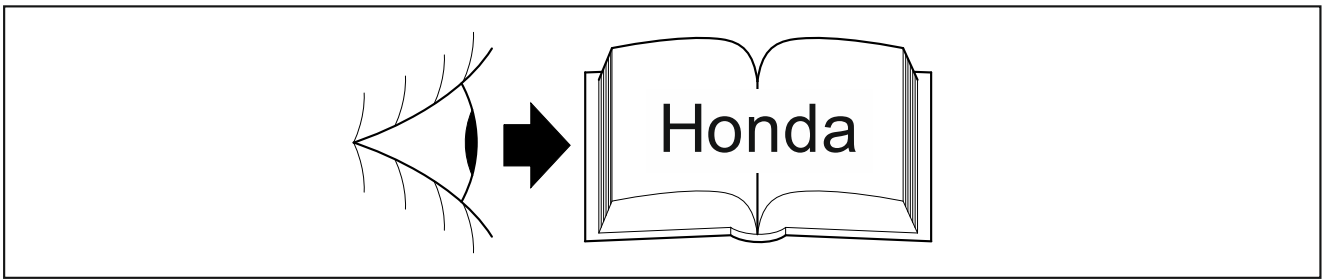

2

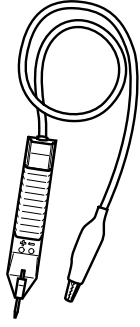
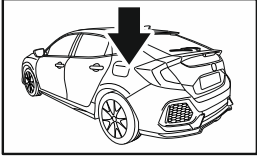

		gy ?
<del>gy</del>	=	

		light bn ?
<del>light bn</del>	=	

		ye ?
<del>ye</del>	=	
		light gn ?
<del>light gn</del>	=	
		gn ?
<del>gn</del>	=	

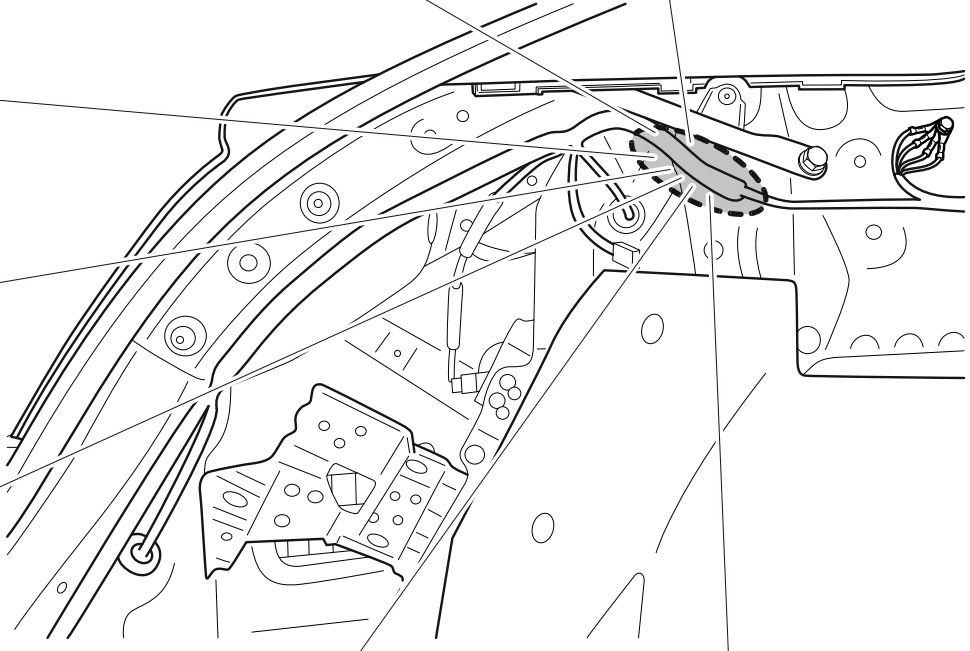

		gy ?
<del>gy</del>	=	

		gy ?
<del>gy</del>	=	

3

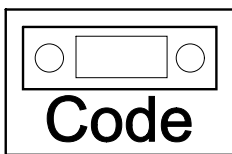
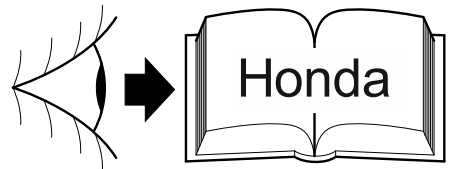
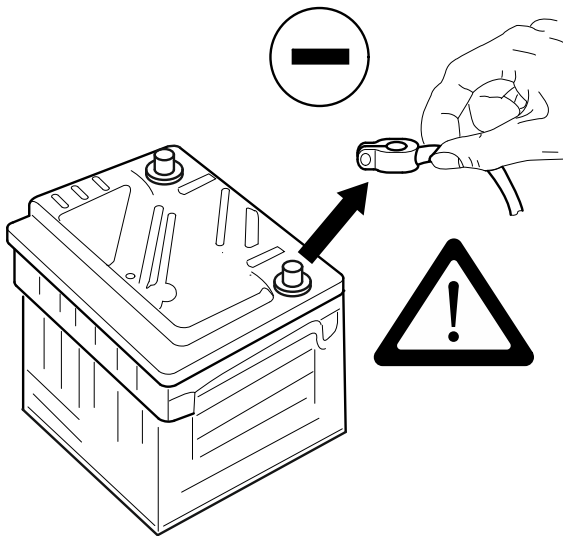



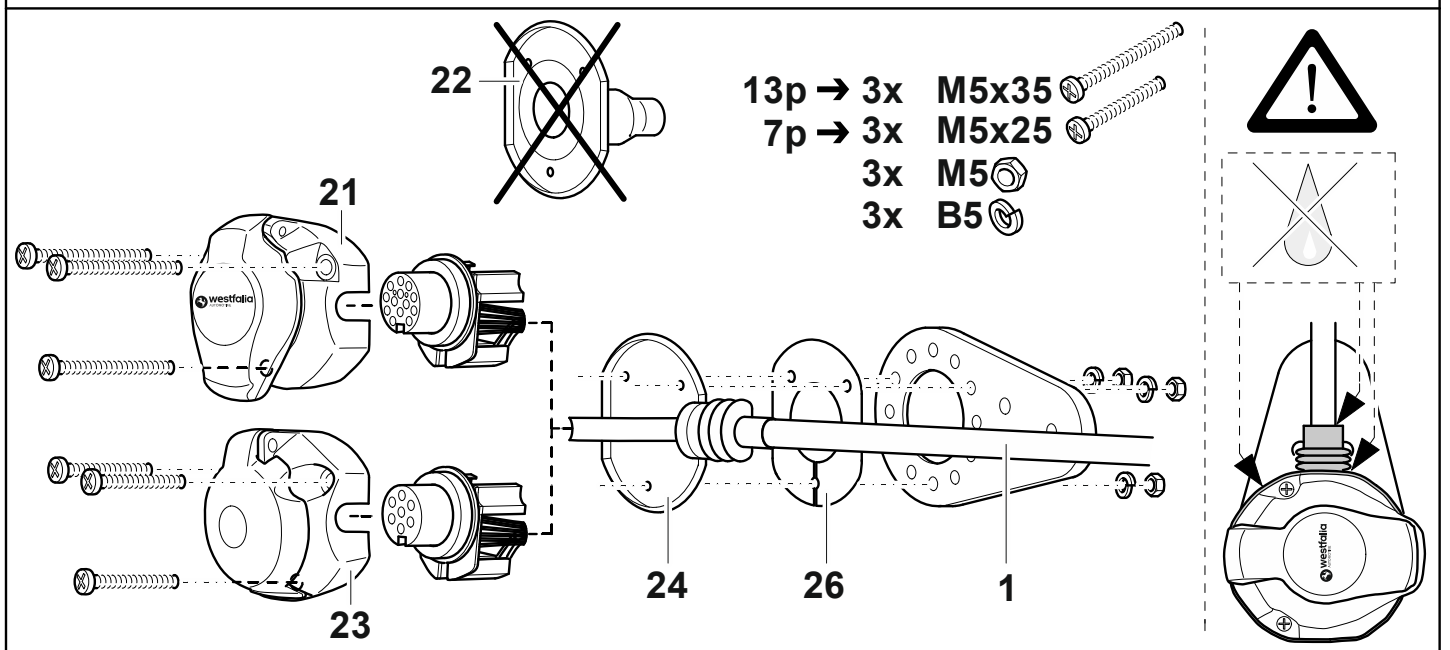
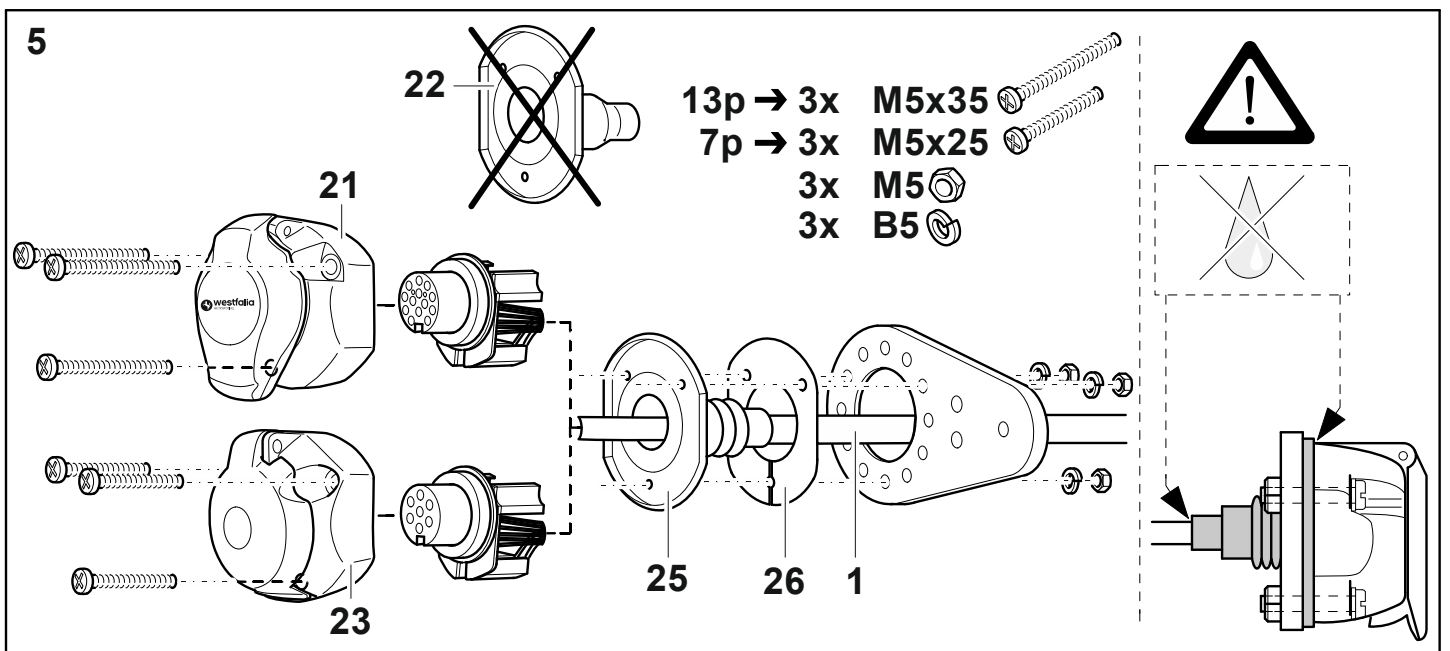
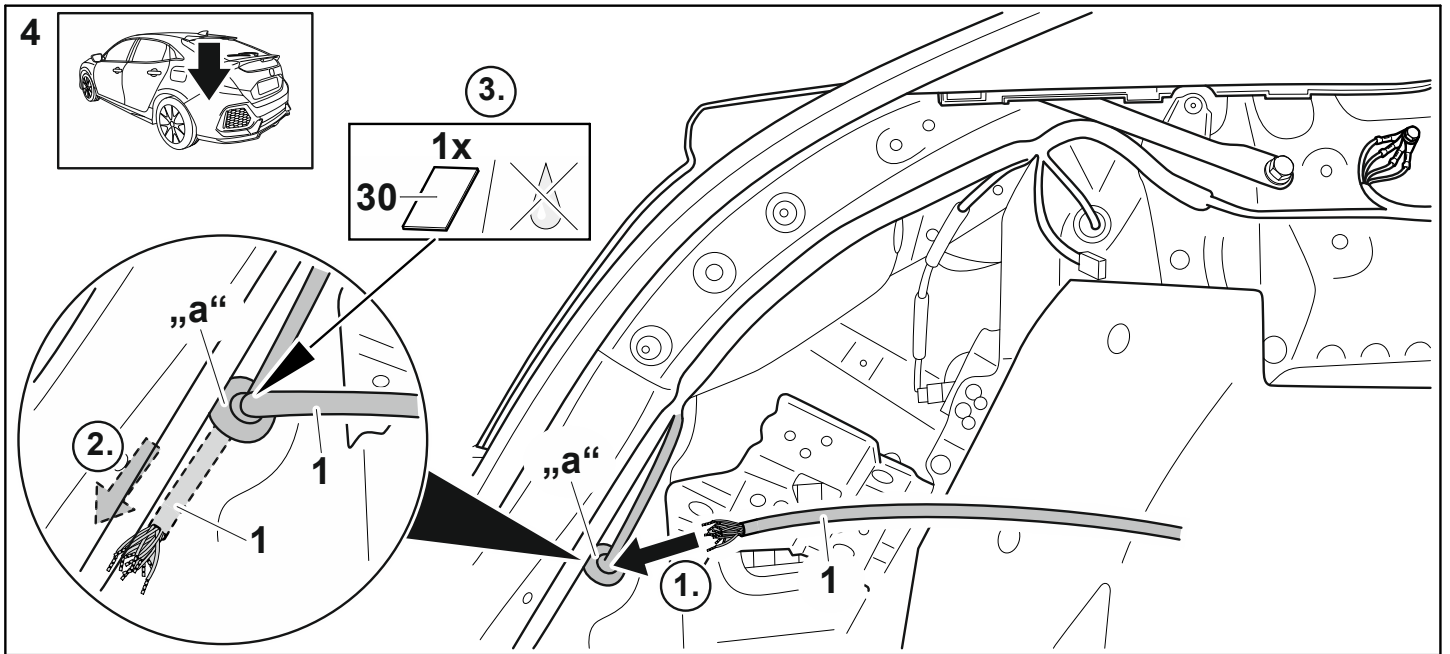

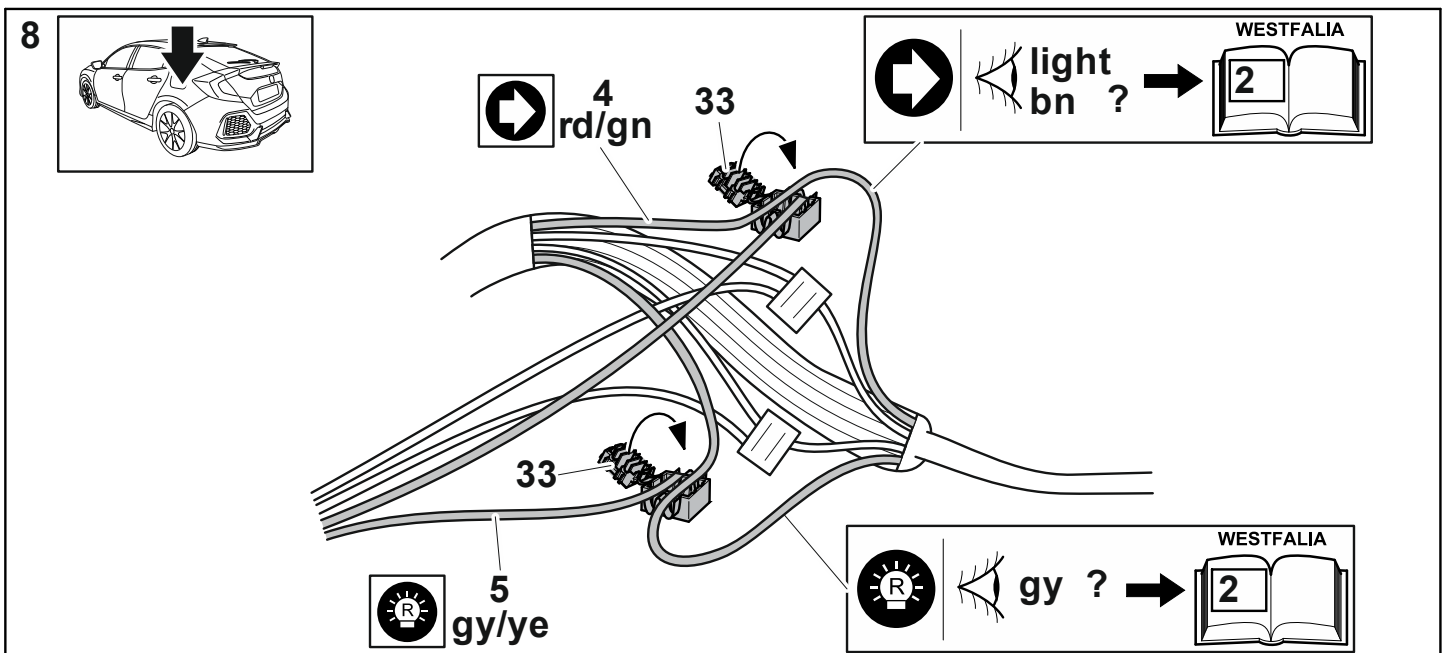
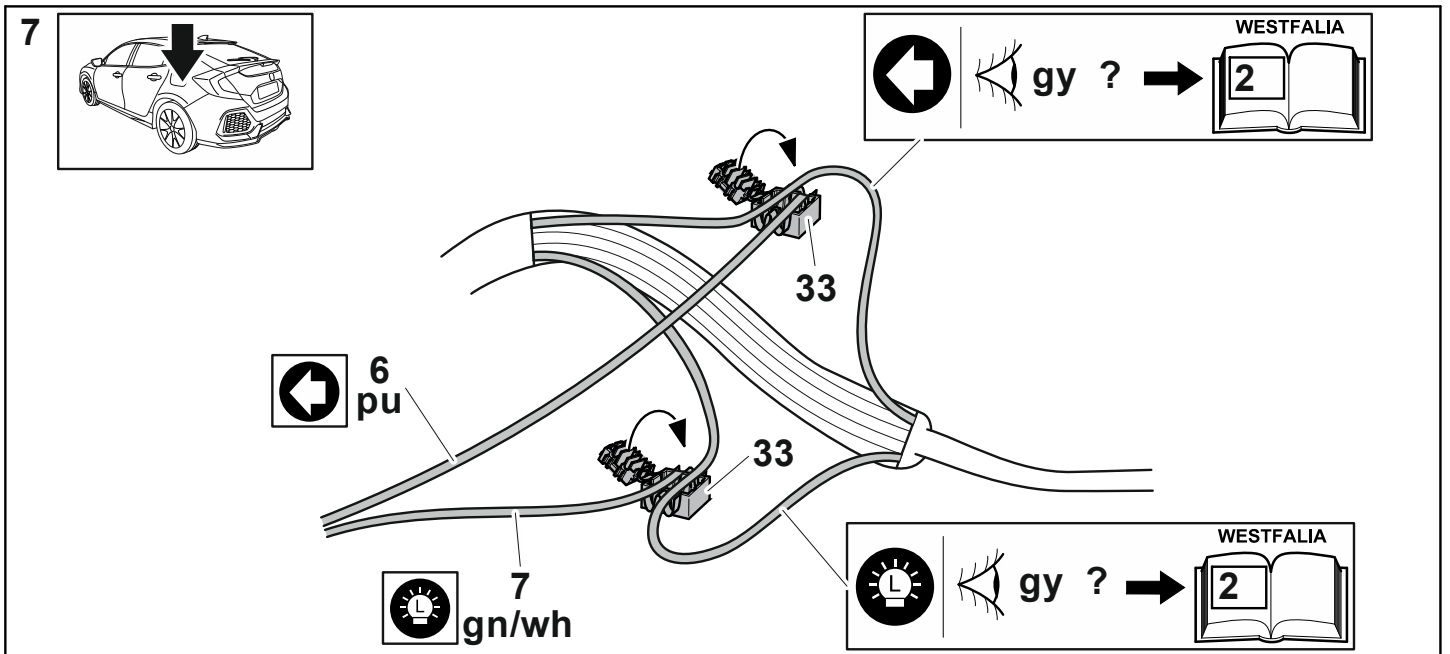
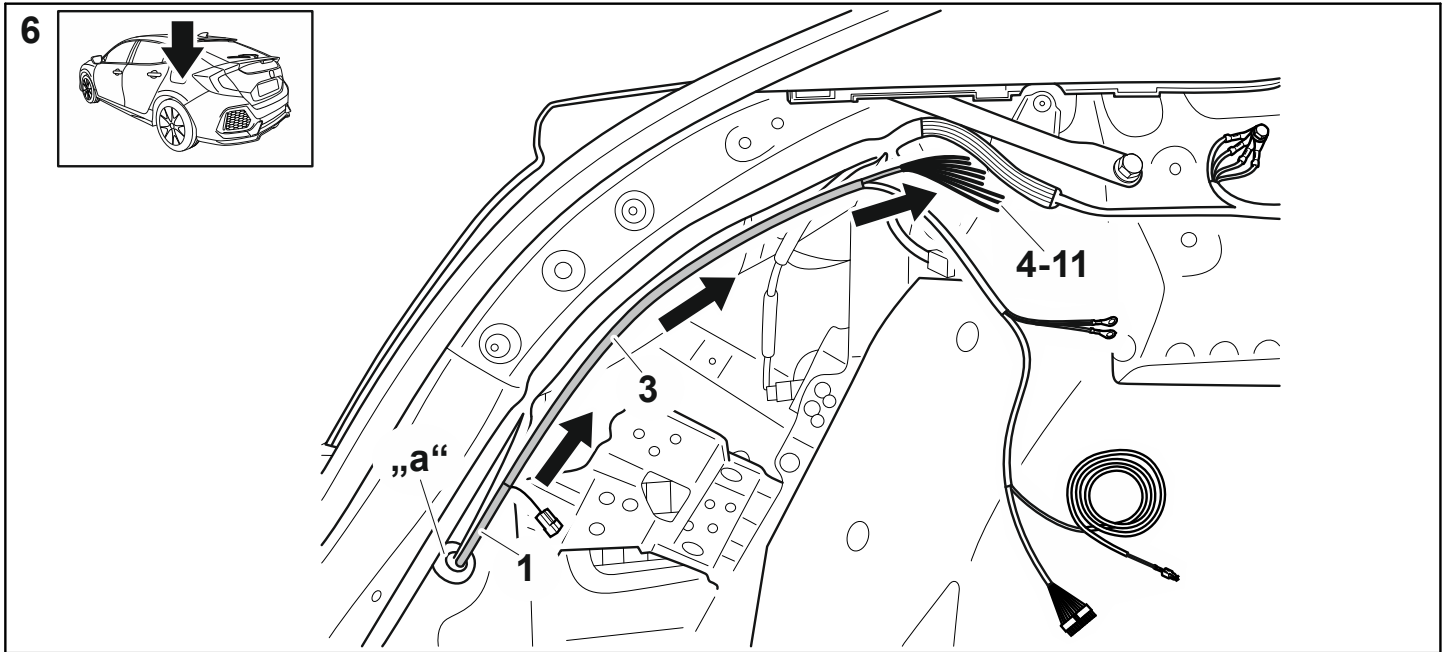

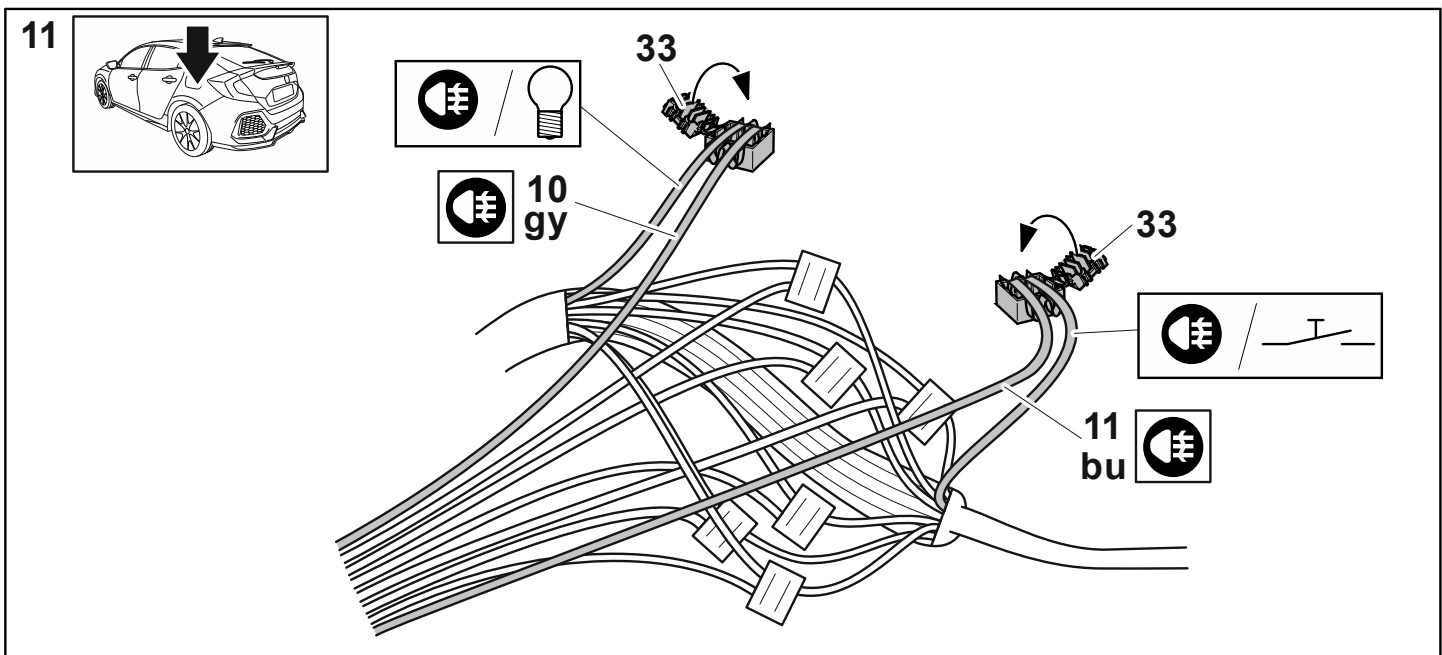
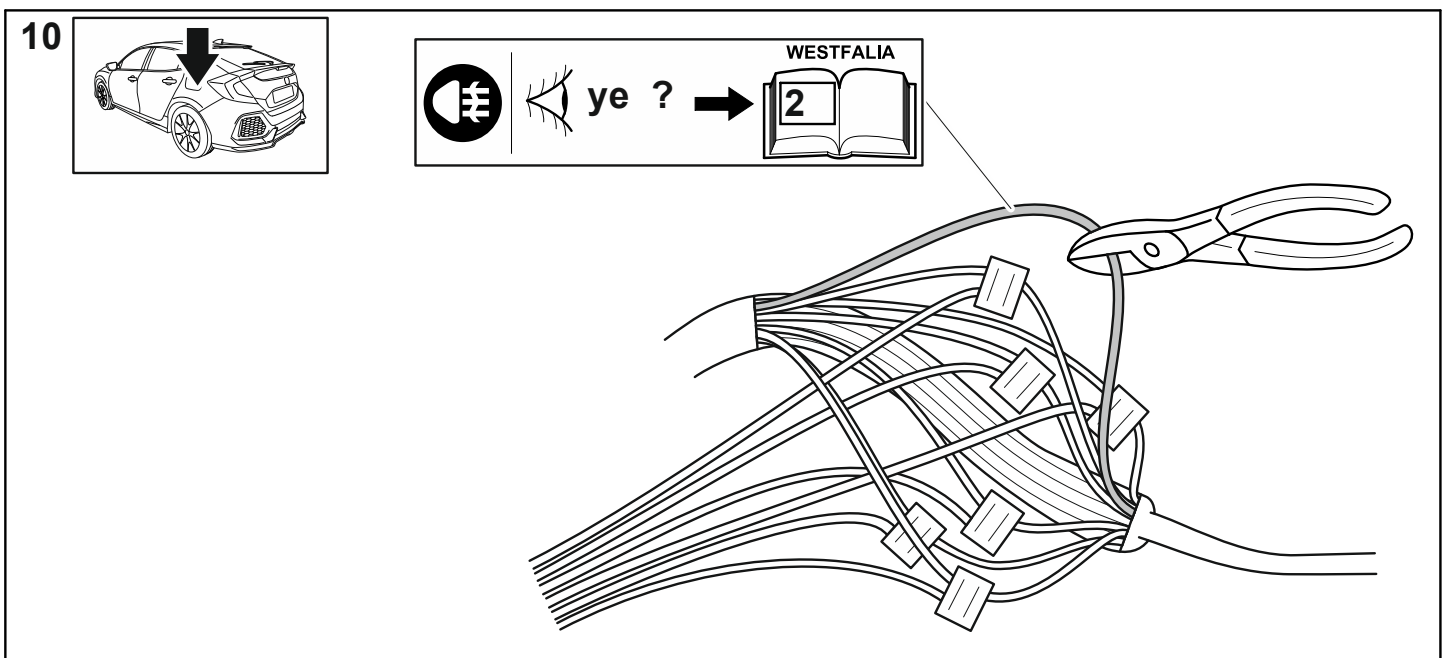
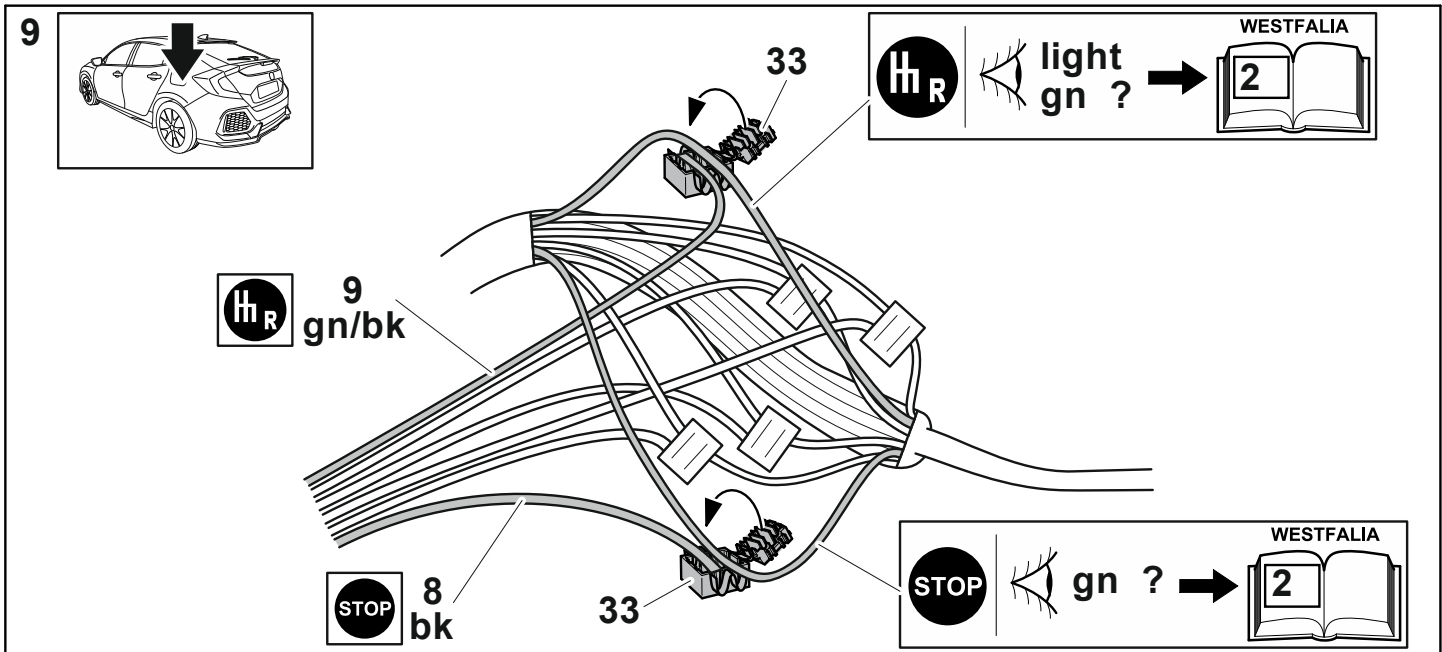

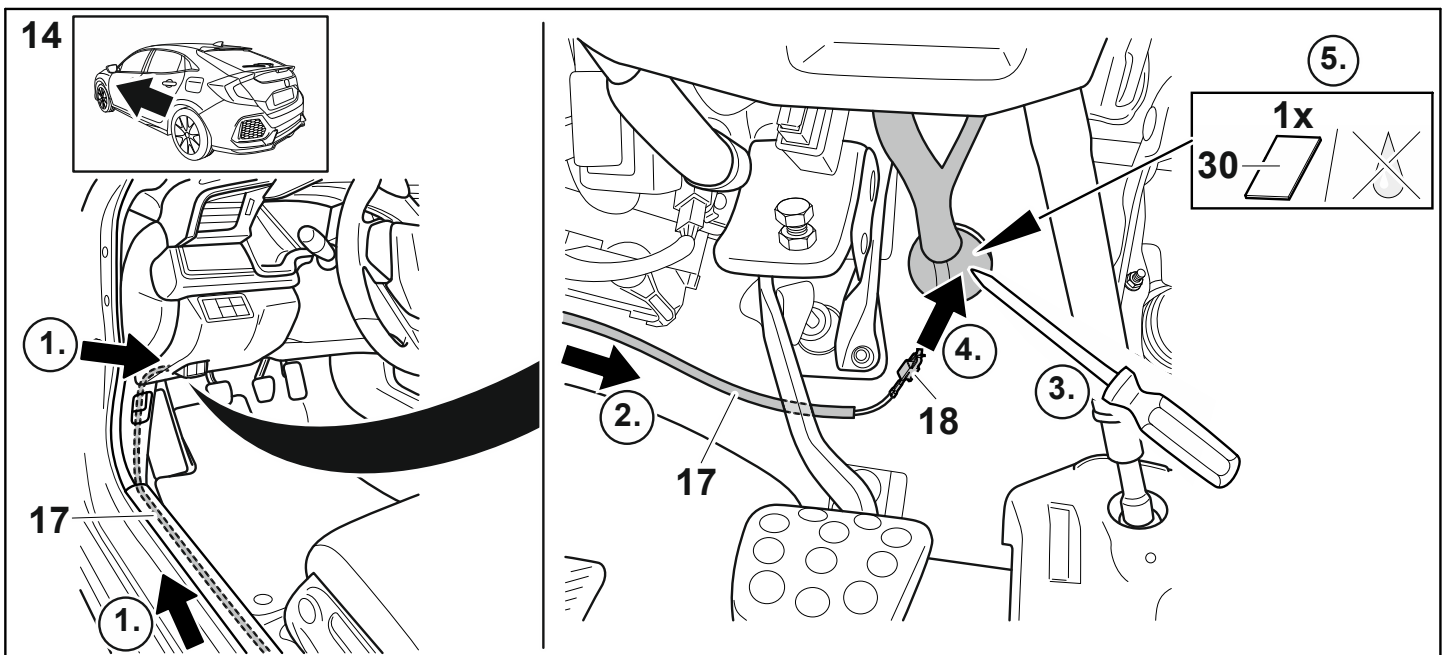
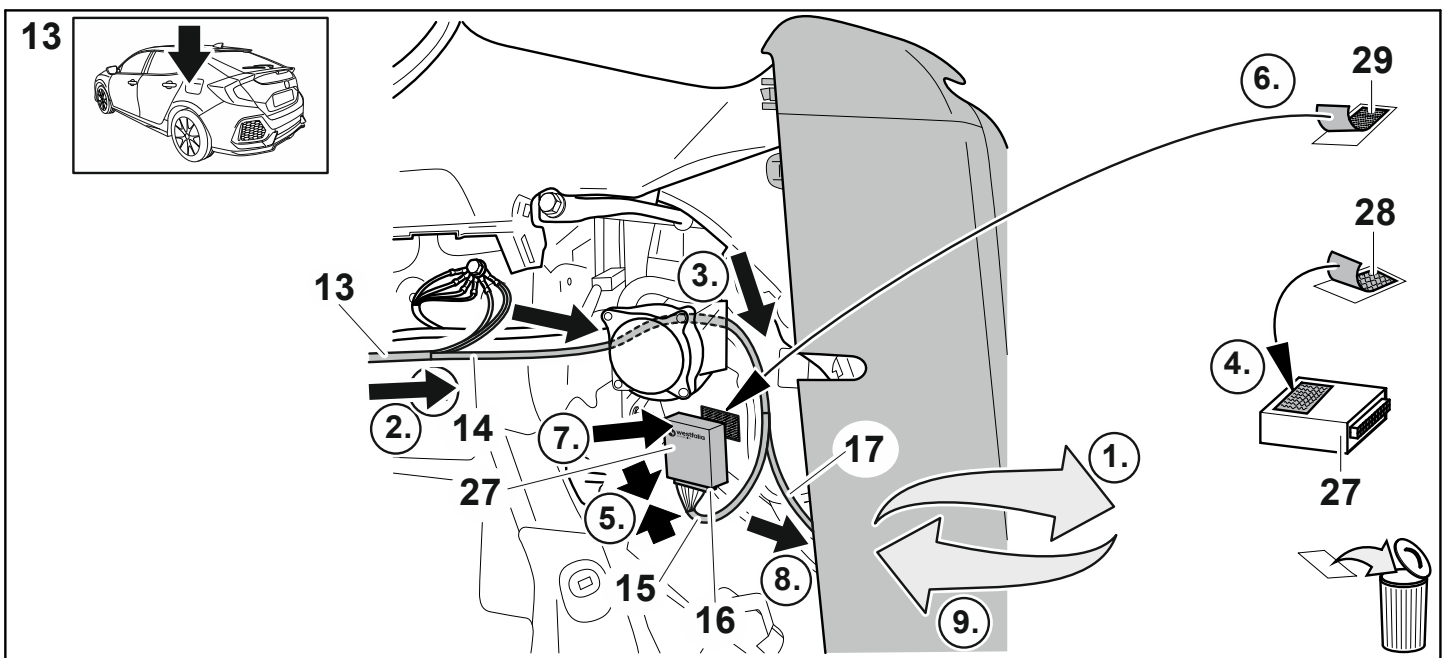
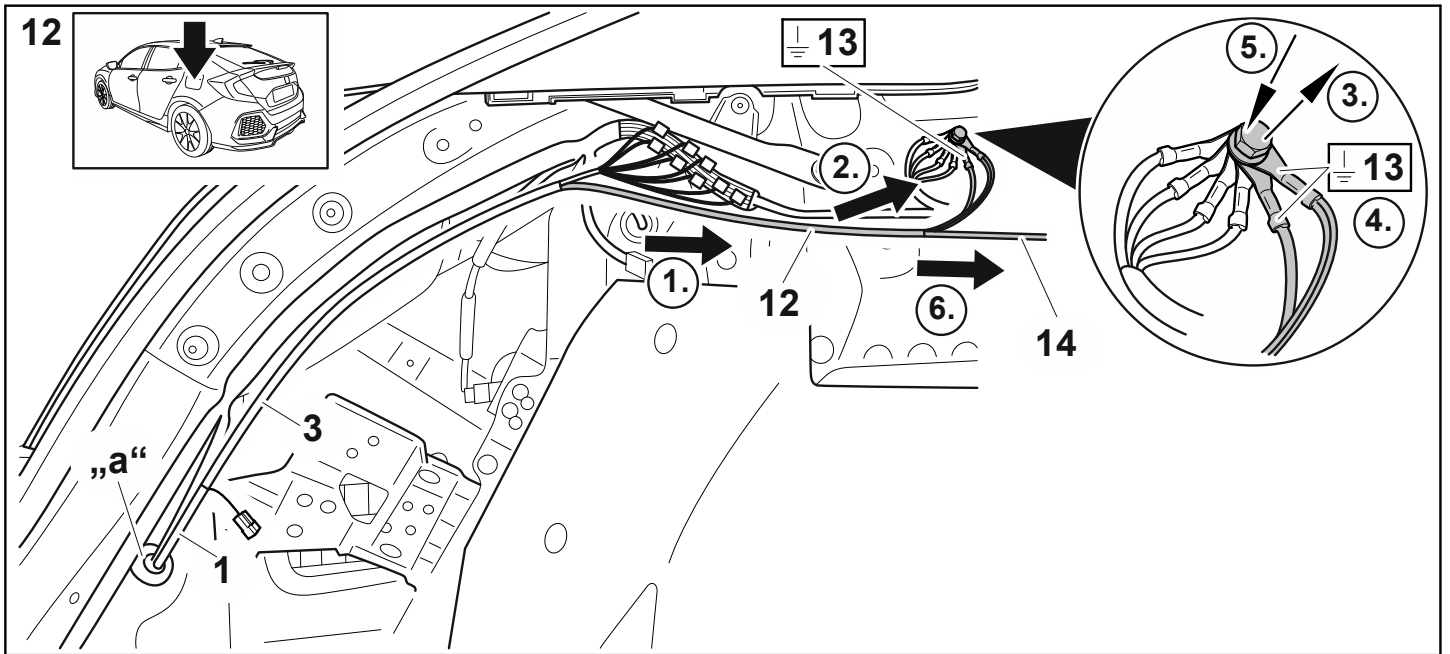

15

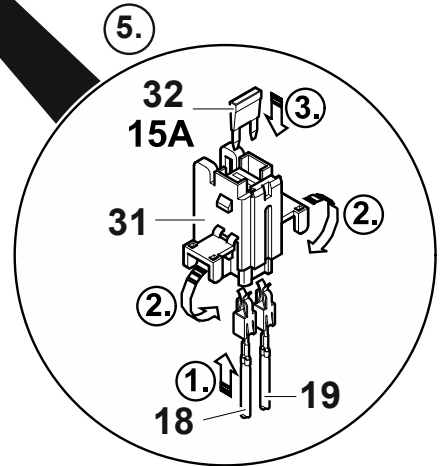
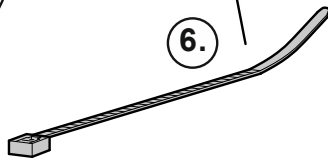
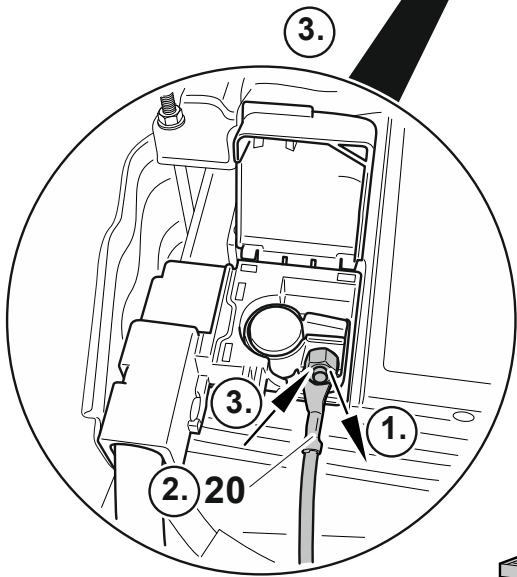
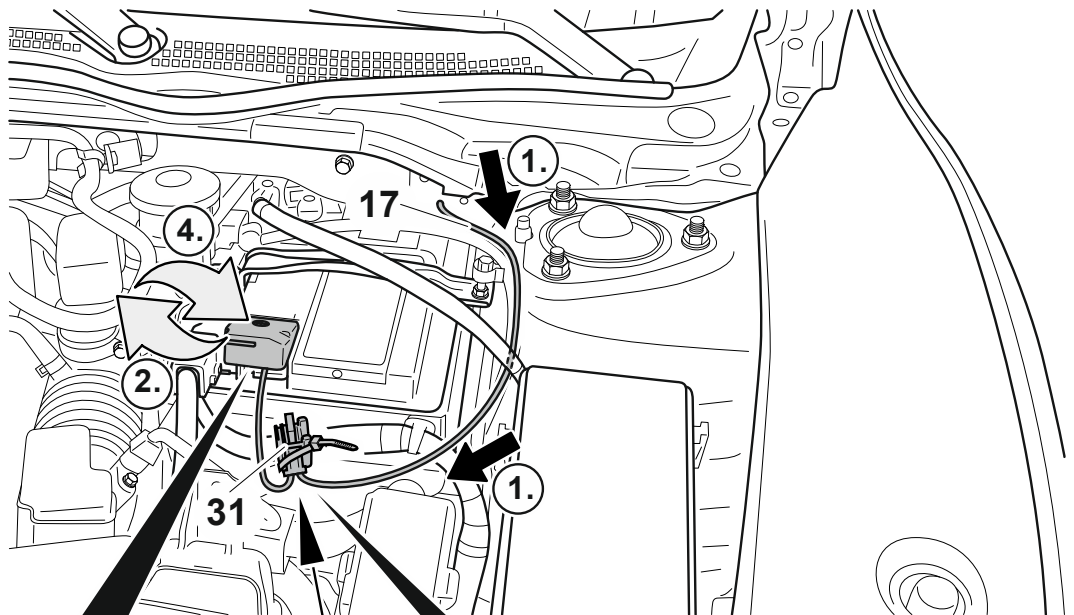
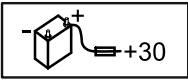
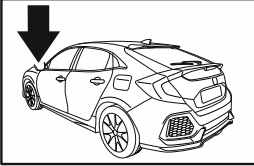

16

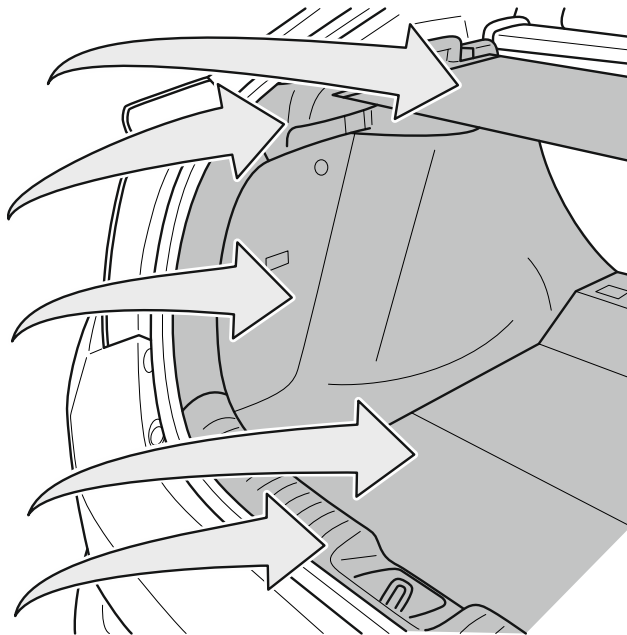
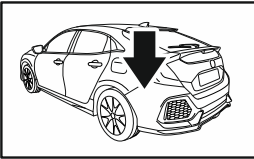

17

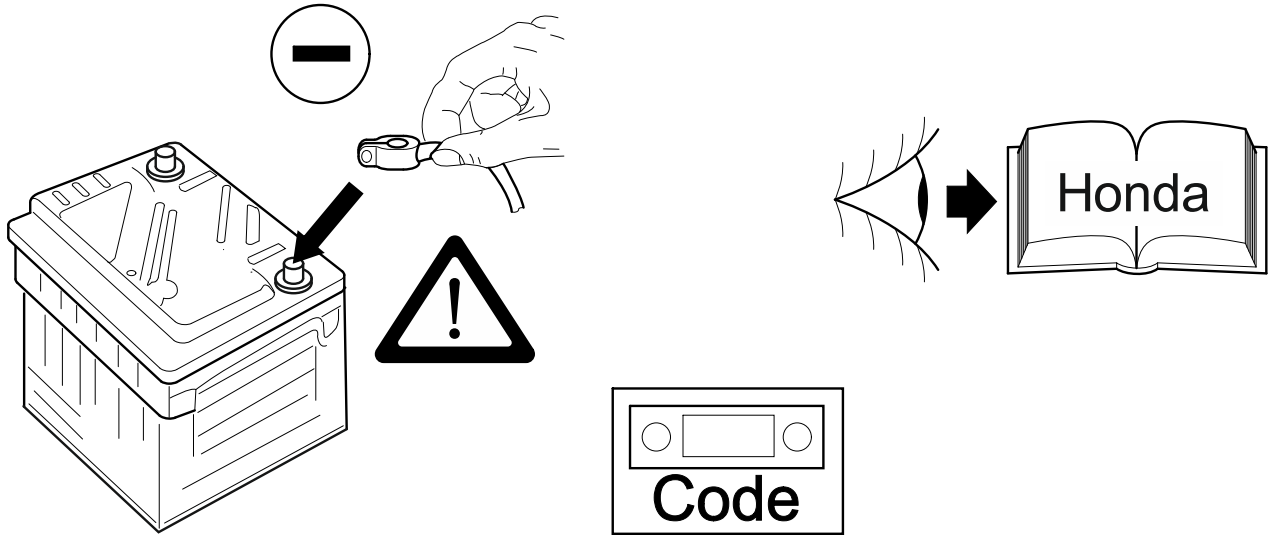

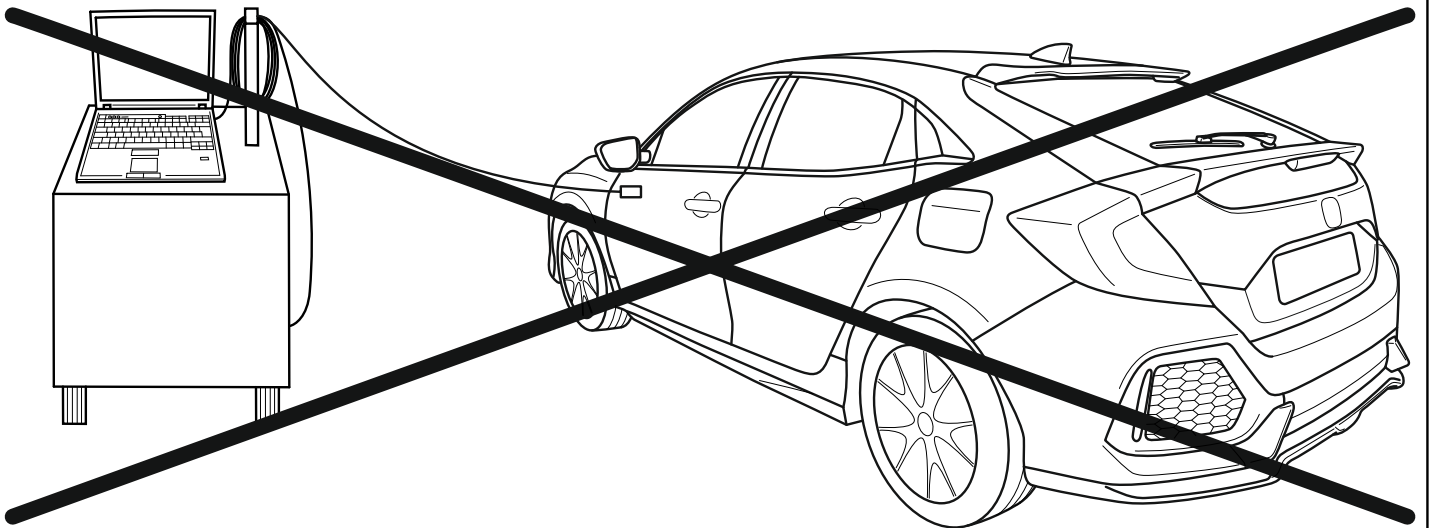

18

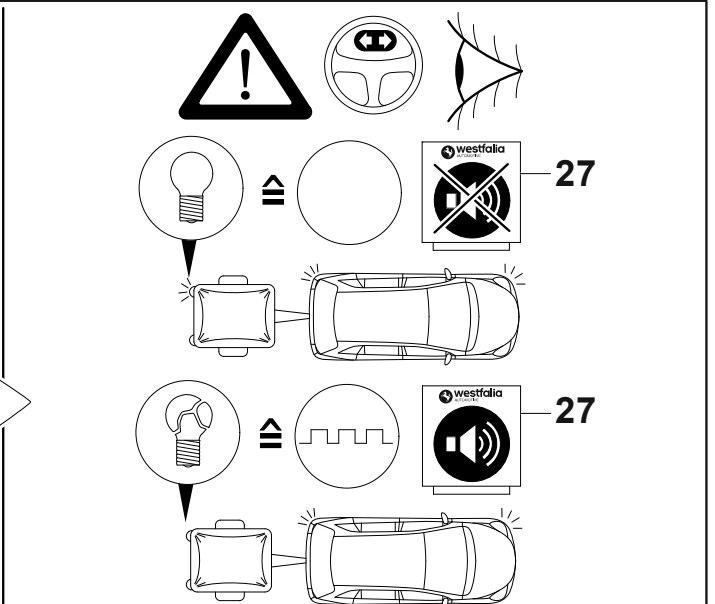
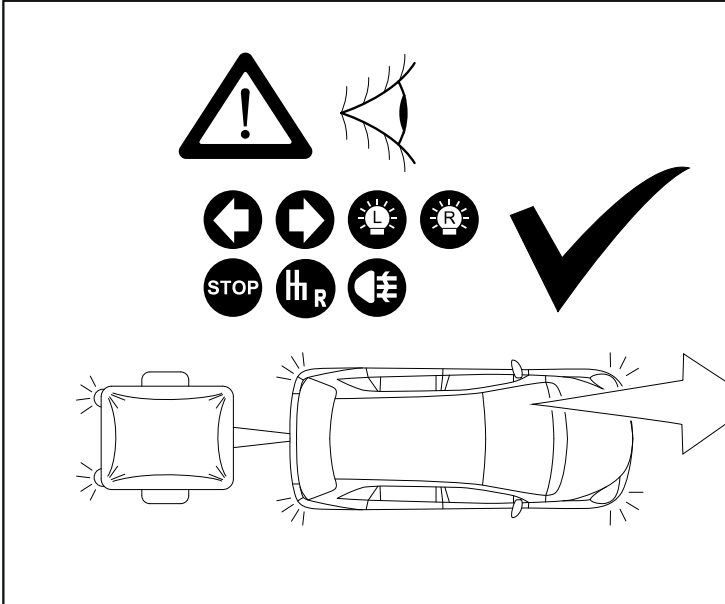
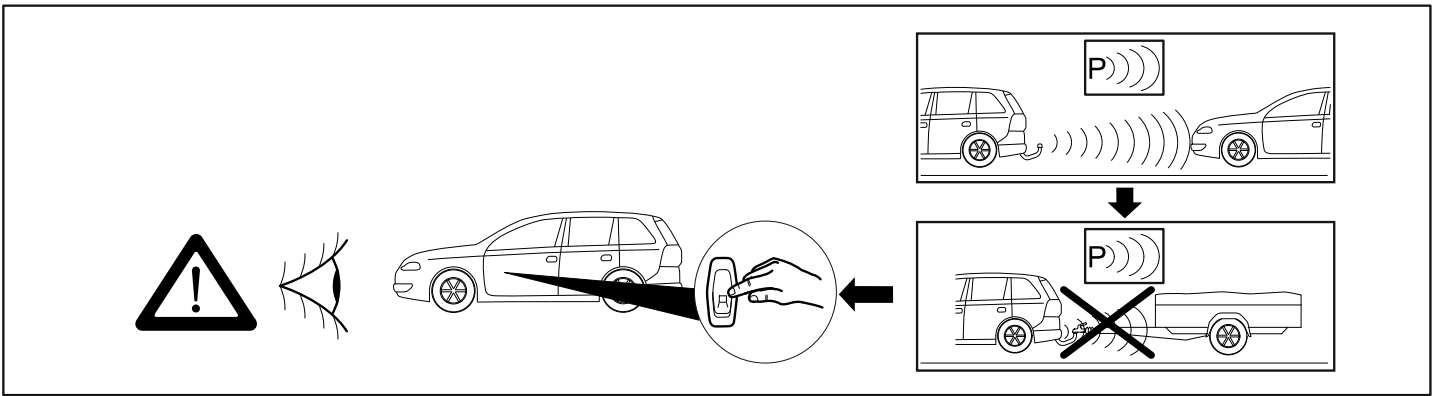

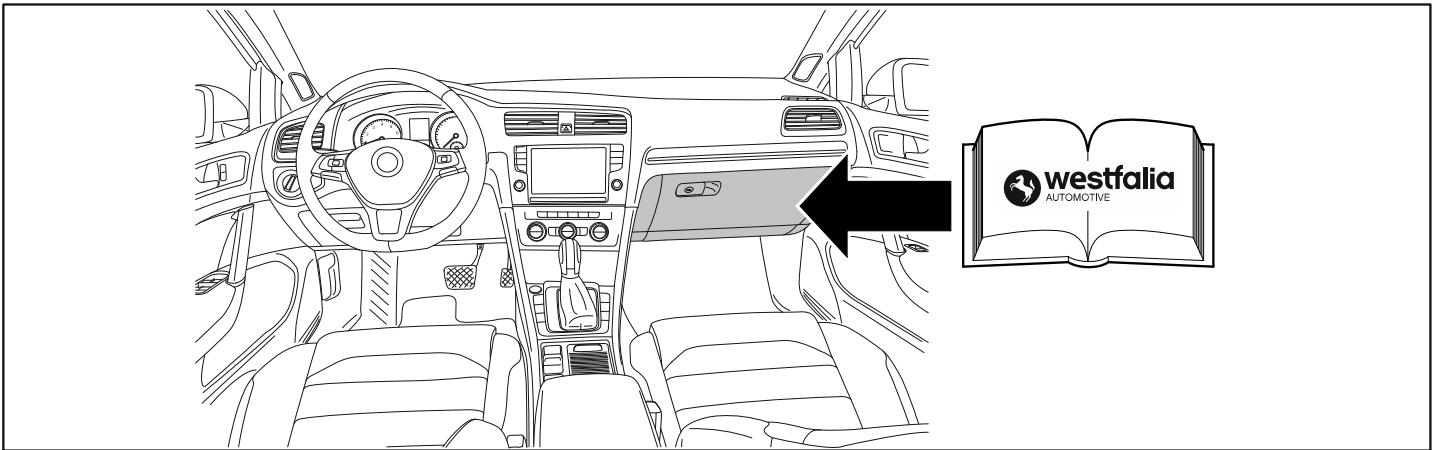
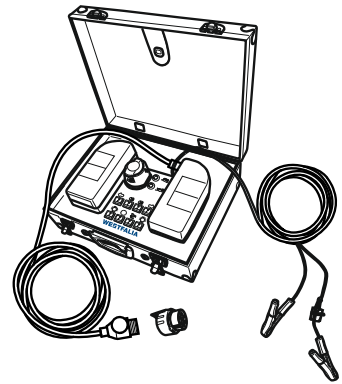

**Trailer simulation for carcheck 7-pin and 13-pin**  
**WA no.: 900 001 300 198**

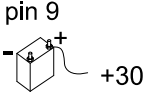
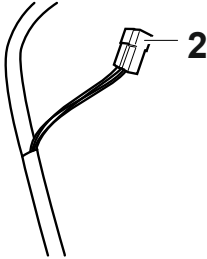

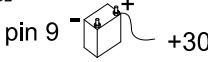
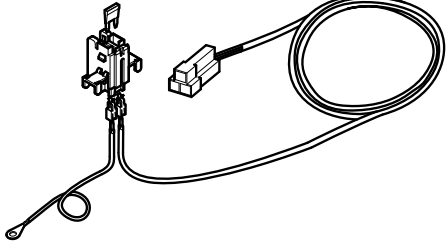





pin 9 +30

2

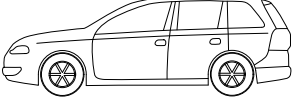
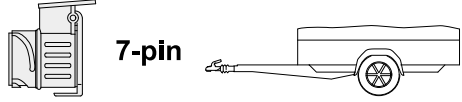
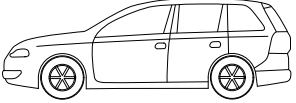
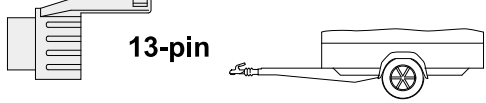
pin 9 +30

WA no.: 300 027 300 113





Optional:  
Adapter socket

13-pin 7-pin

WA no.: 300 100 320 113

7-pin 13-pin

WA no.: 300 100 310 107







WA no.  
900 001 506 439

WA no.  
900 001 506 633

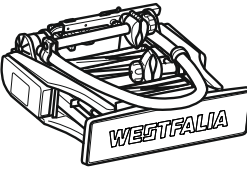
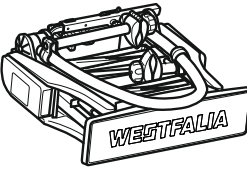
WA no.  
900 001 506 024

WA no.  
900 001 506 102

Westfalia Cycle Carrier  
WA no.: 350 050 600 001

Box  
WA no.: 350 002 600 001