

x 2

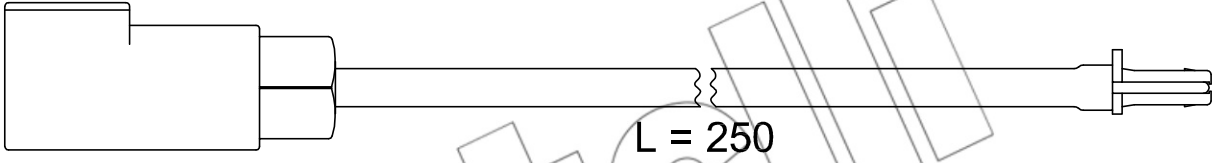

L = 250

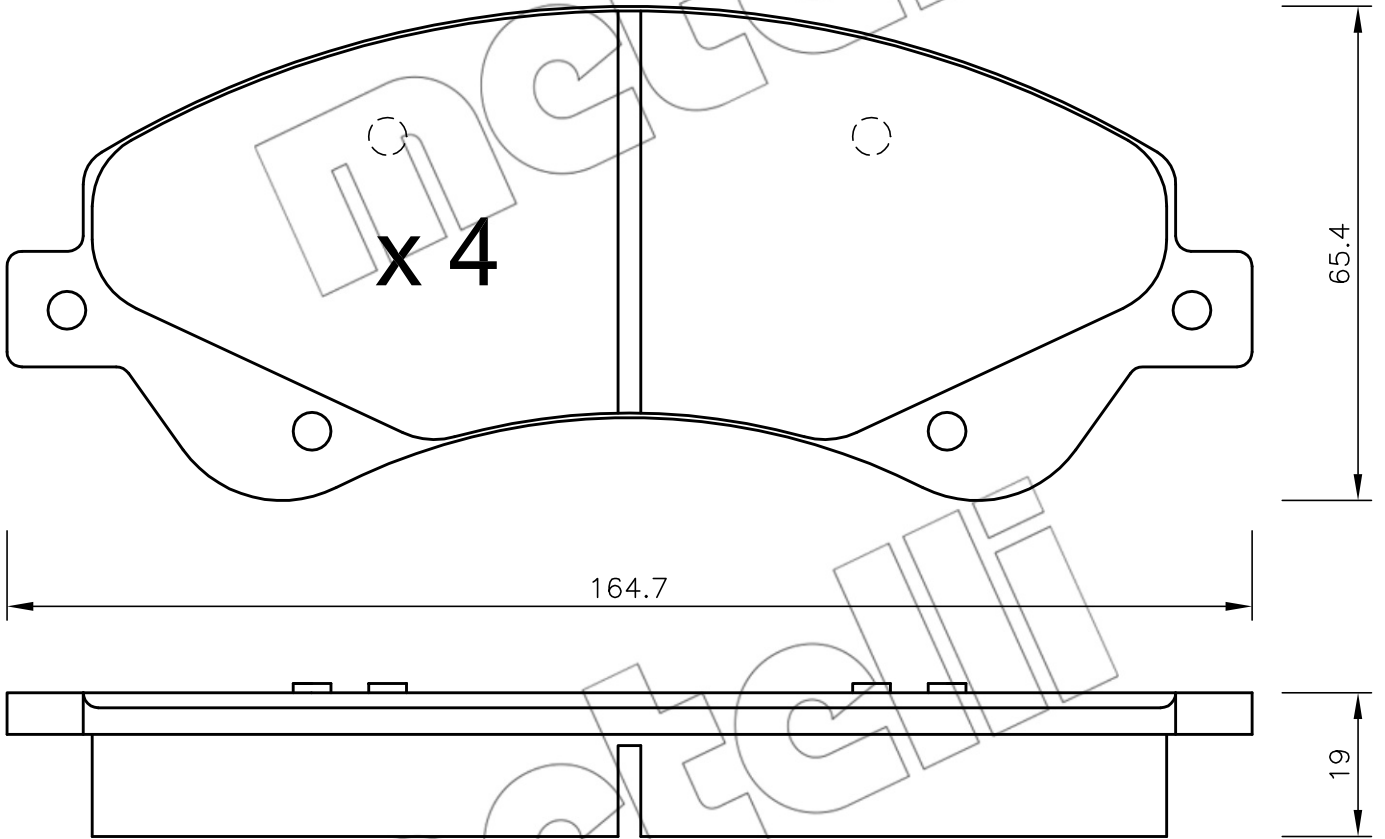

x 4

164.7

65.4

19

metelli