

x 1  L = 170

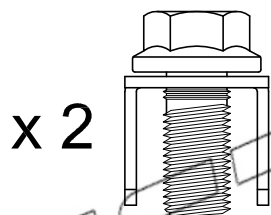
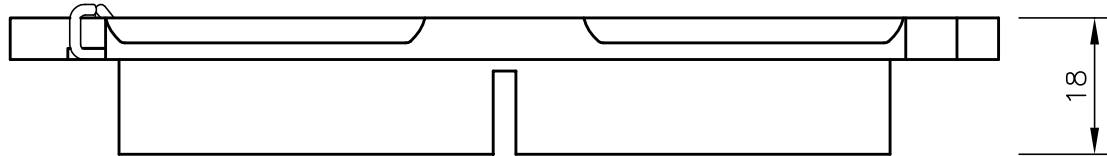
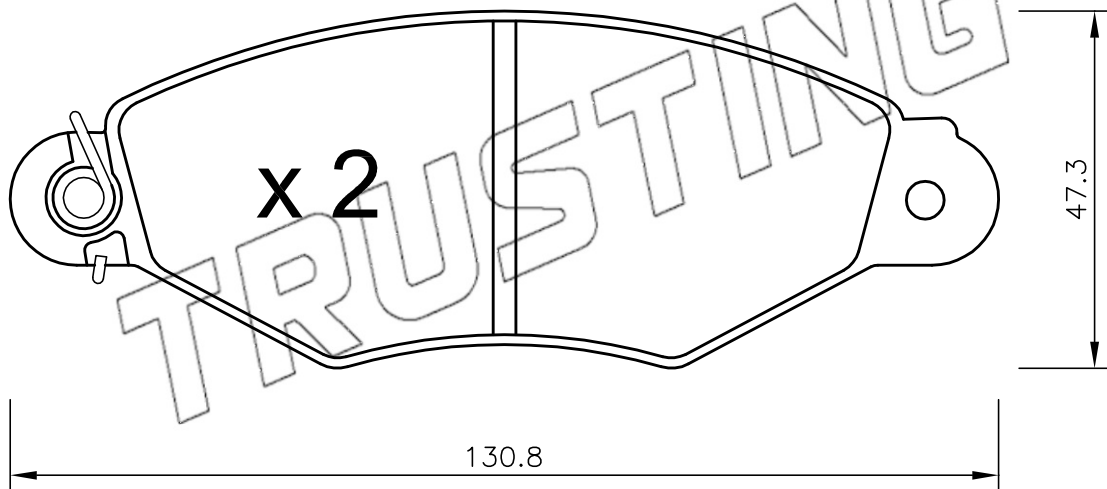
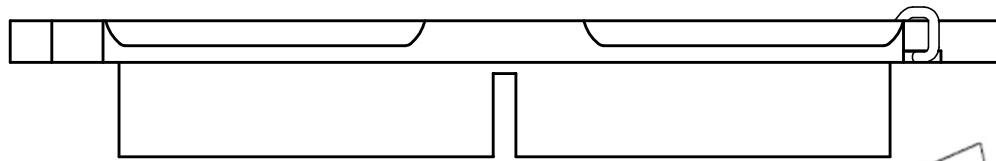
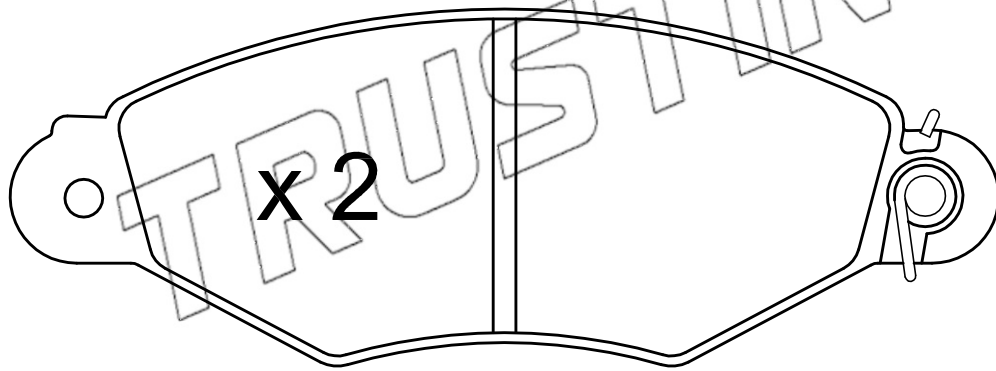

TRUSTING