

x 1

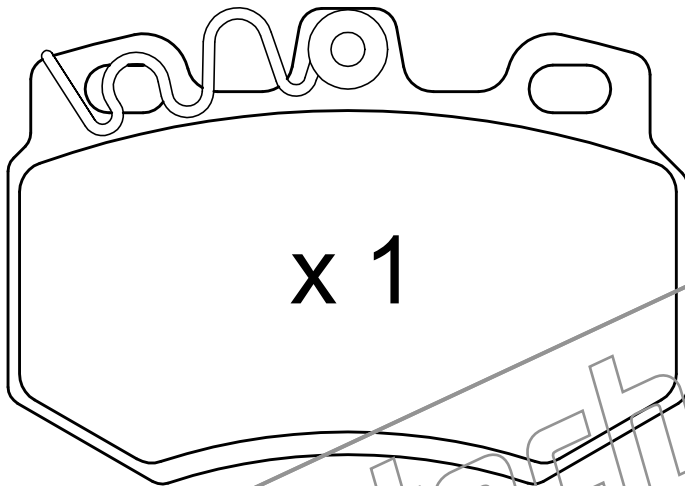

x 1

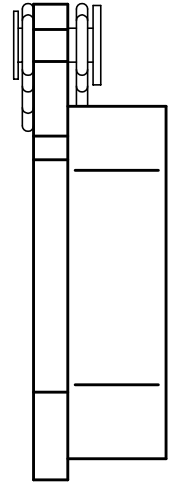
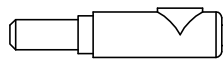
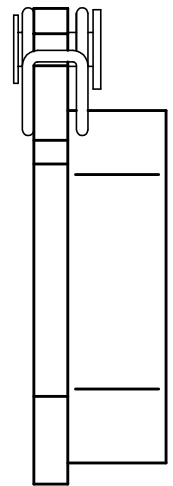

L = 230

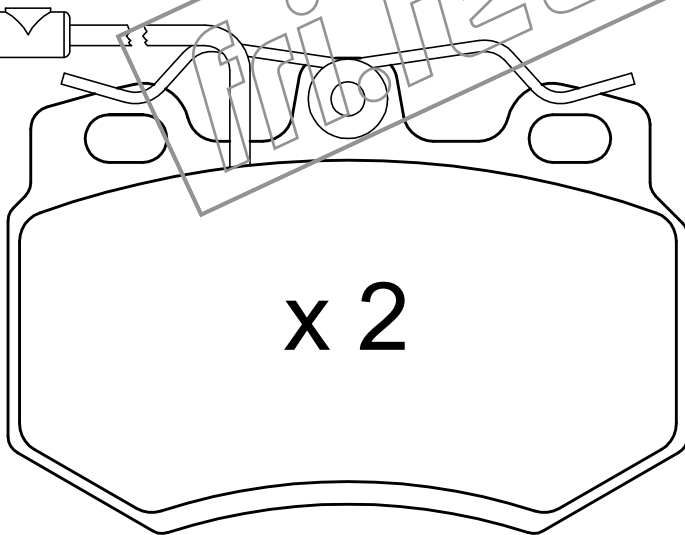

x 2

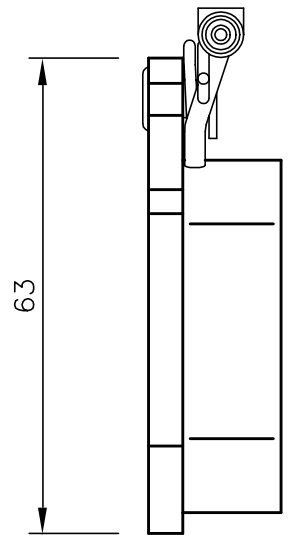

63

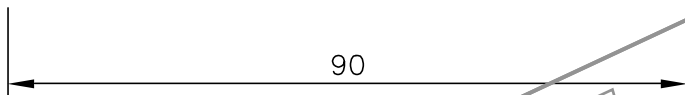

90

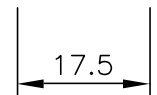

17.5

