

L = 125

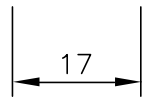
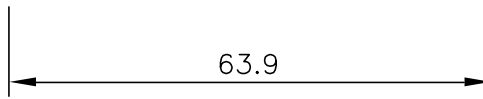
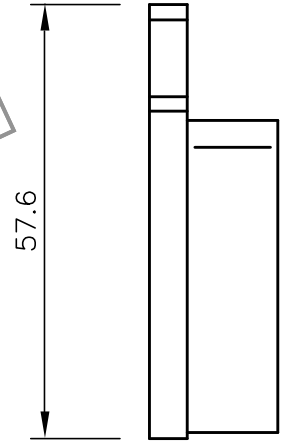
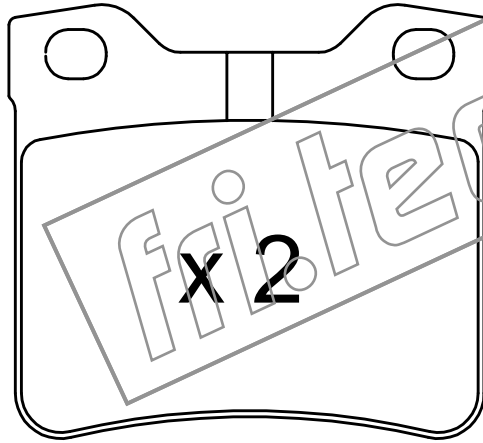
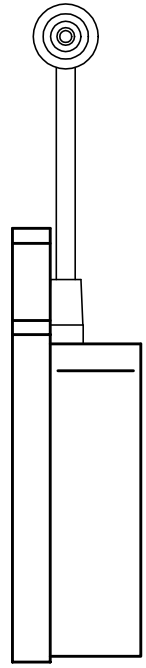
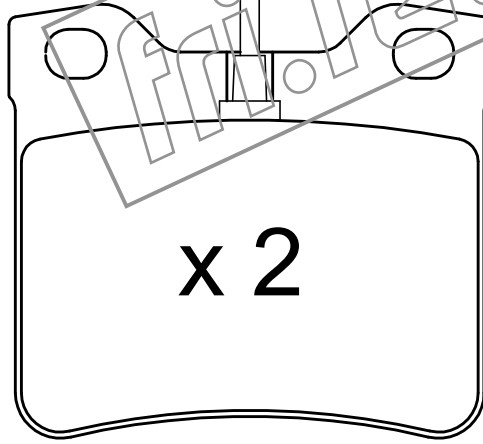

fri.tech.