

x 2 L = 140

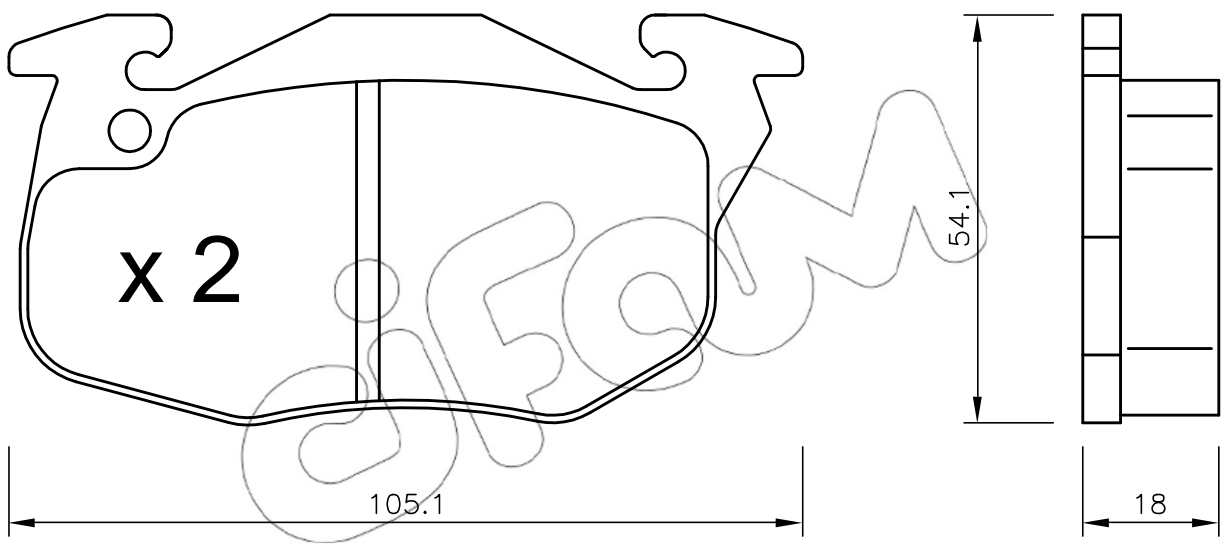
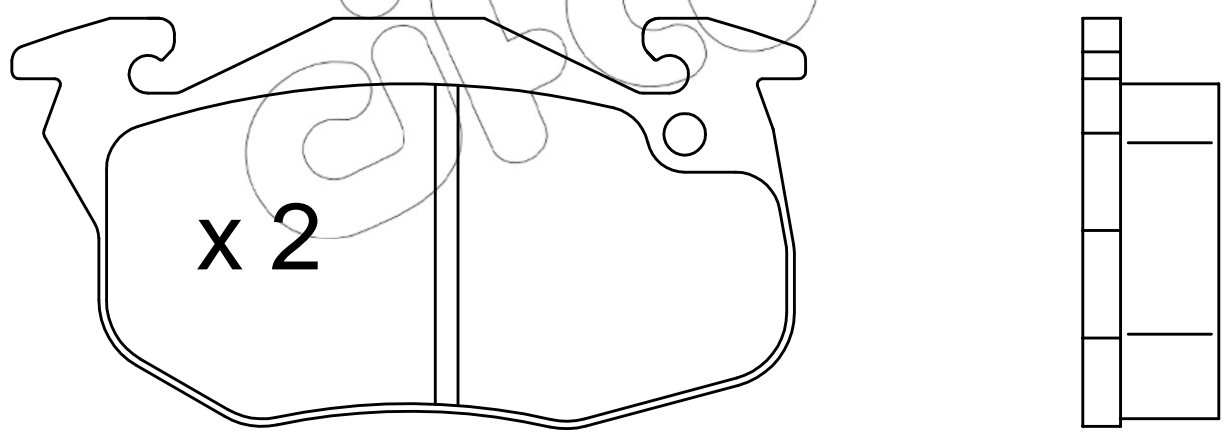

ifom