

TECHNICAL DATA SHEET

Type No.: AGM L3
Created : 05.02.2022
Modified : 05.02.2022

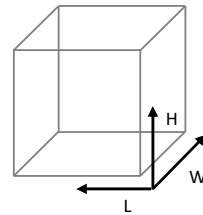
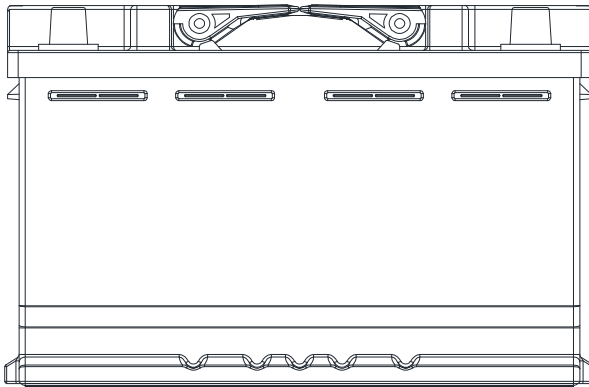
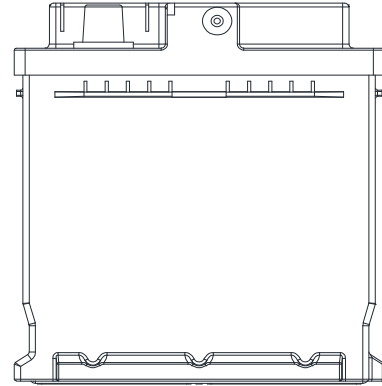
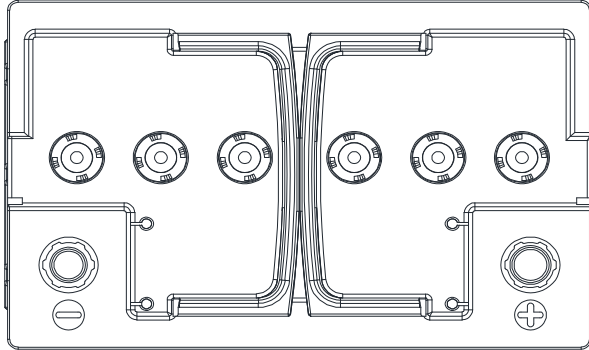

PERFORMANCE			CONTAINER		
VOLTAGE(V):	12	V	Group:	L3	Black
C20(Ah):	70	Ah	Hold Down:	B13	
RC(min):	140	min	Please refer to the catalog or our website for the details of hold down types of the battery container.		
CCA(A):	680	EN	COVER		
Vibration:	V3		Type:	6-valved cap	Black
Endurance:	E4		Polarity:	L	
Water consumption:	W5		Terminals:	Standard	
Technology:	VRLA		Filter:	2 Filters both sides	
Grid alloy:	Ca/Ca		HANDLES		
WEIGHT AND STD. DIMENSION			Handles:	2 handles	
Battery weight(kg):	20,50		REMARK		
Volume acid(l):	3,57				
Length(mm):	277				
Width(mm):	174				
Height(mm):	190				
Total Height(mm):	190				