

MIN THK 23 MM

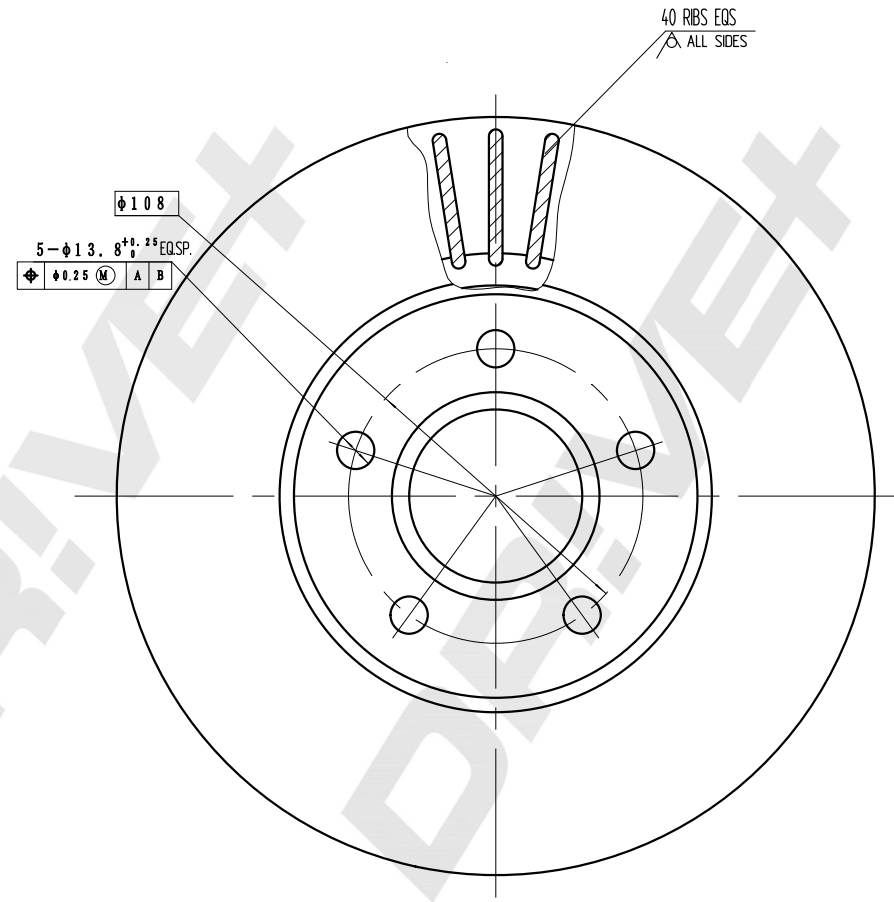

DP Number	Part Number	Drawing Version Number	Drawing Issue Date
DP1010.11.0854C	DBD0854C	V1	2025.04.13

