

MIN THK 23 MM

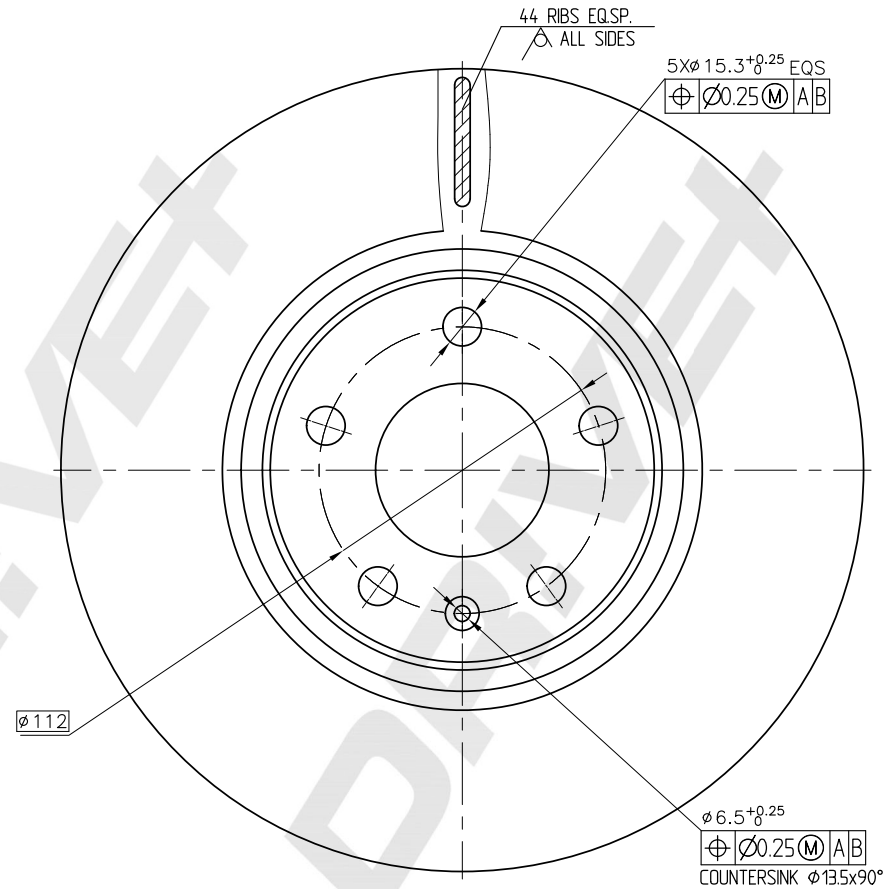

DP Number	Part Number	Drawing Version Number	Drawing Issue Date	DRIVET
DP1010.11.1409C	DBD1409C	V1	2025.04.19	