

MIN THK 28 MM

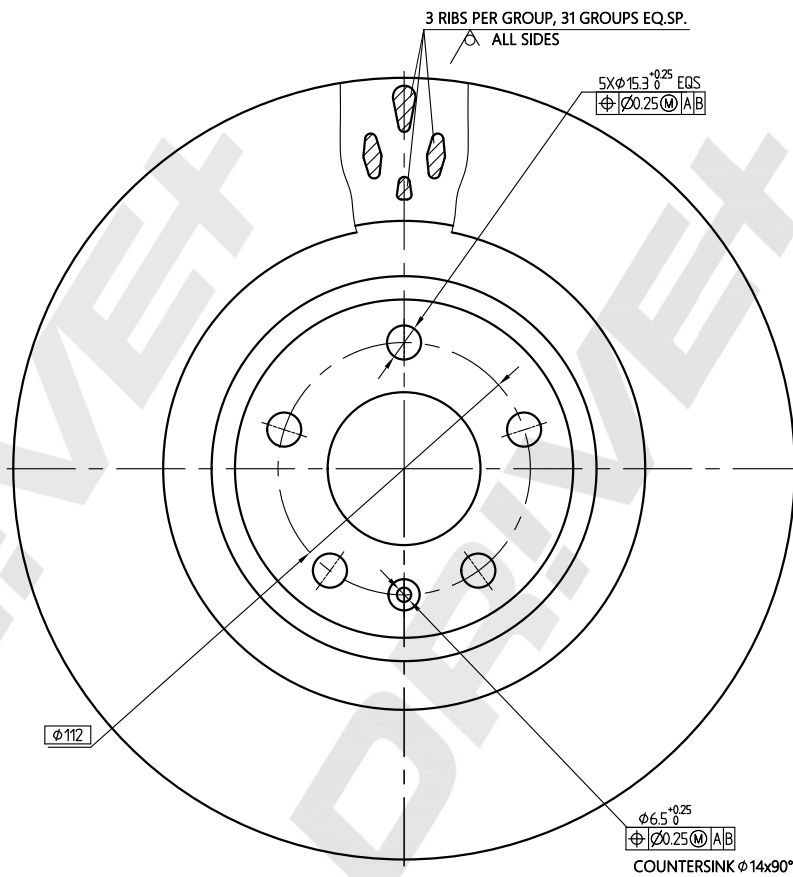

DP Number	Part Number	Drawing Version Number	Drawing Issue Date
DP1010.11.1671C	DBD1671C	V1	2025.04.19

DRIVET