

MIN THK 23.4 MM

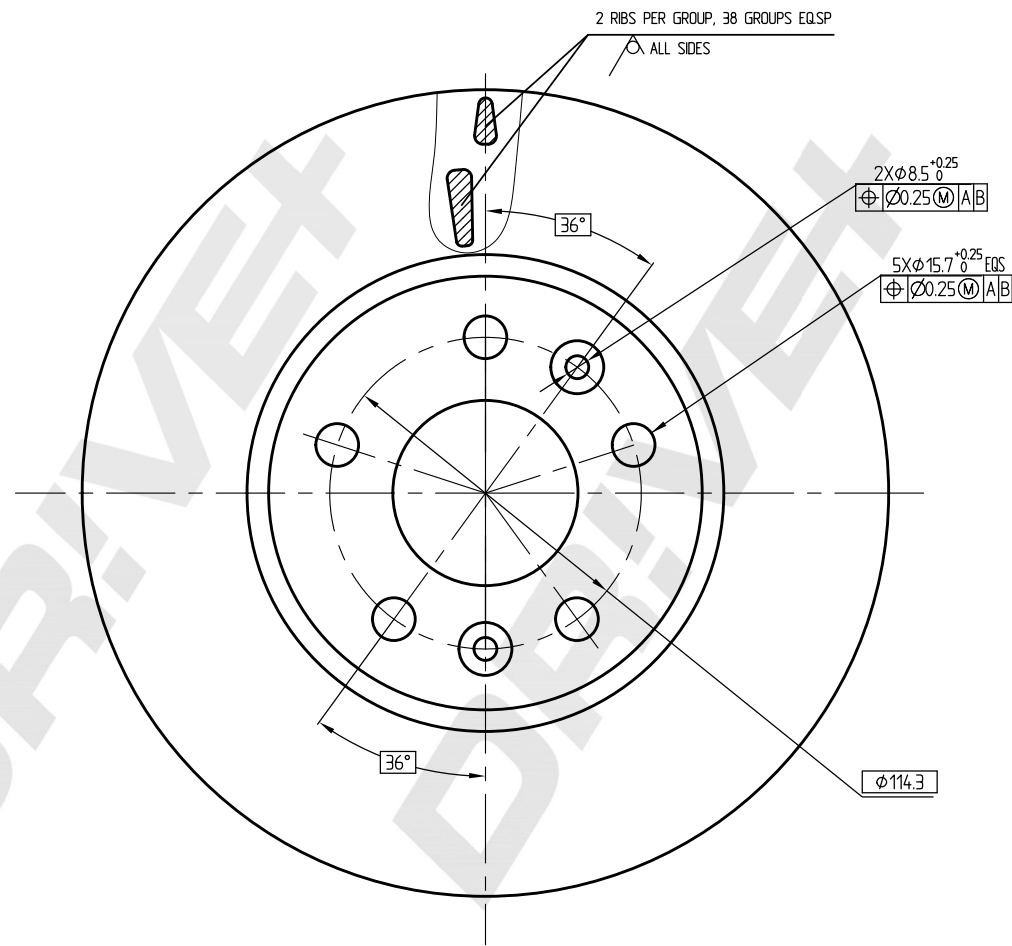

DP Number	Part Number	Drawing Version Number	Drawing Issue Date
DP1010.11.1654	DBD1654	V1	2025.04.19

