

MIN THK 24.5 MM

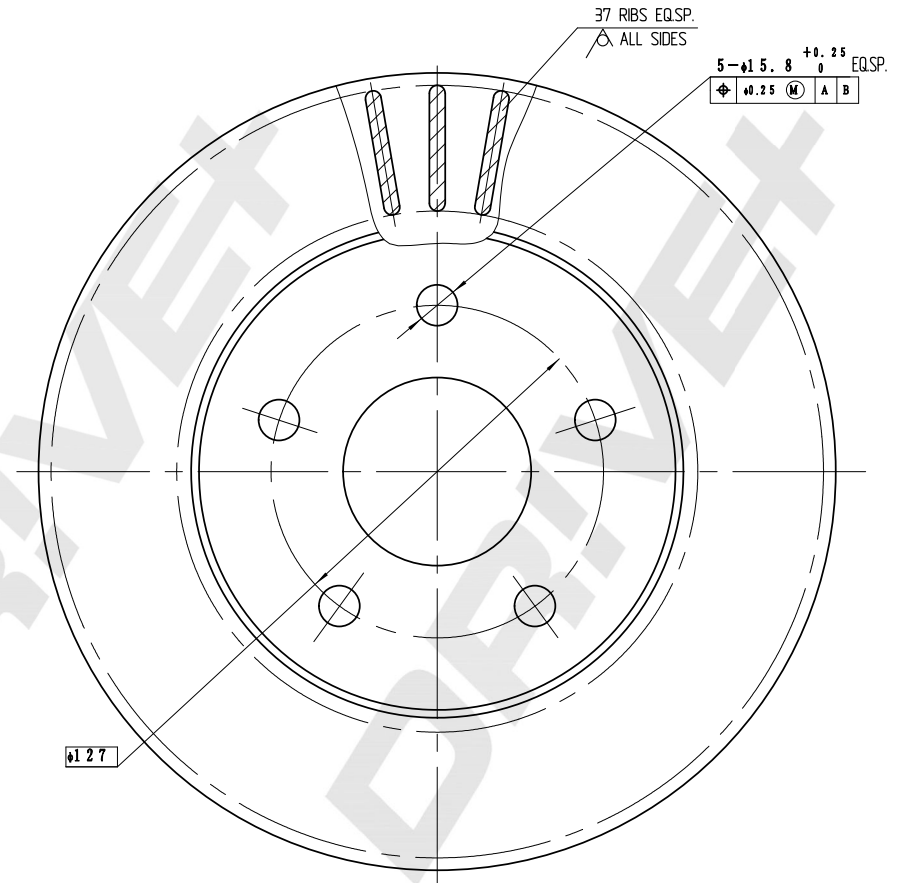

DP Number	Part Number	Drawing Version Number	Drawing Issue Date
DP1010.11.1679	DBD1679	V1	2025.04.19

