

MIN THK 23 MM

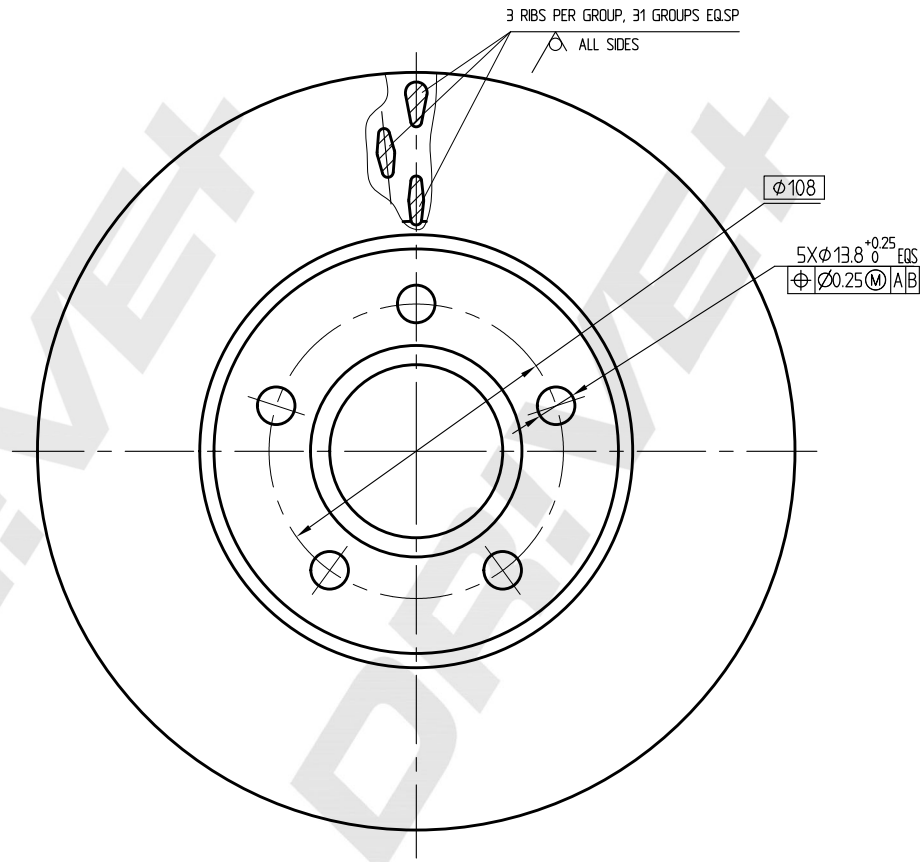

DP Number	Part Number	Drawing Version Number	Drawing Issue Date
DP1010.11.1715	DBD1715	V1	2025.04.19

