

MIN THK 26 MM

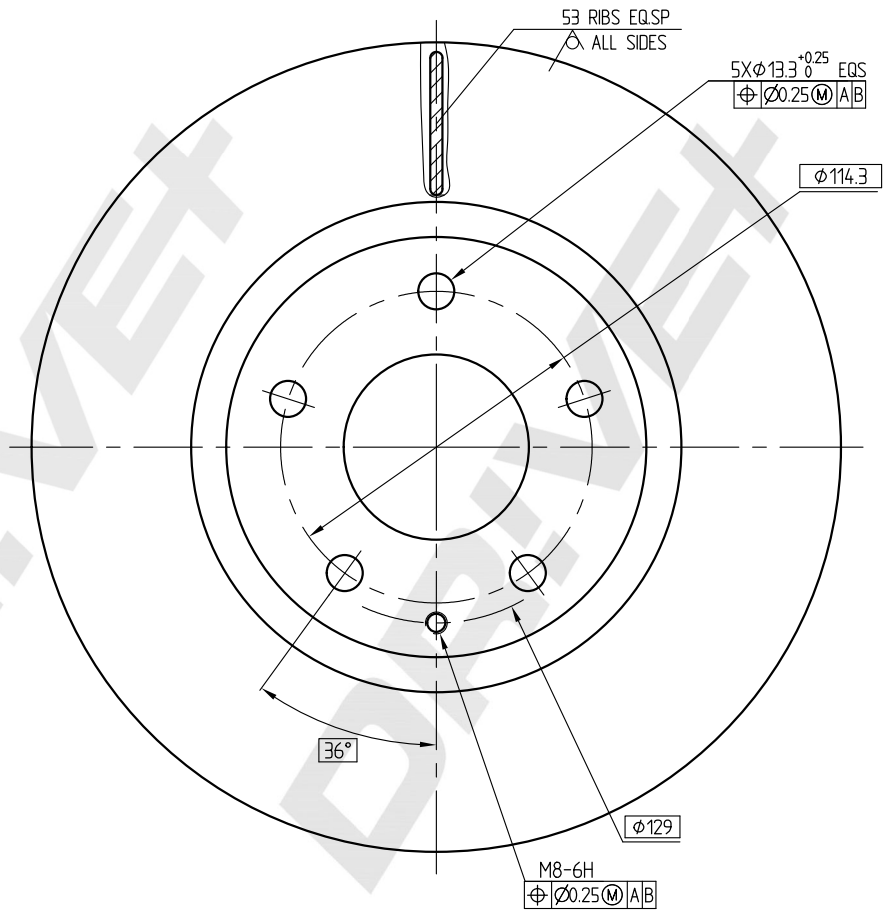

DP Number	Part Number	Drawing Version Number	Drawing Issue Date
DP1010.11.1810	DBD1810	V1	2025.04.19

