

MIN THK 24 MM

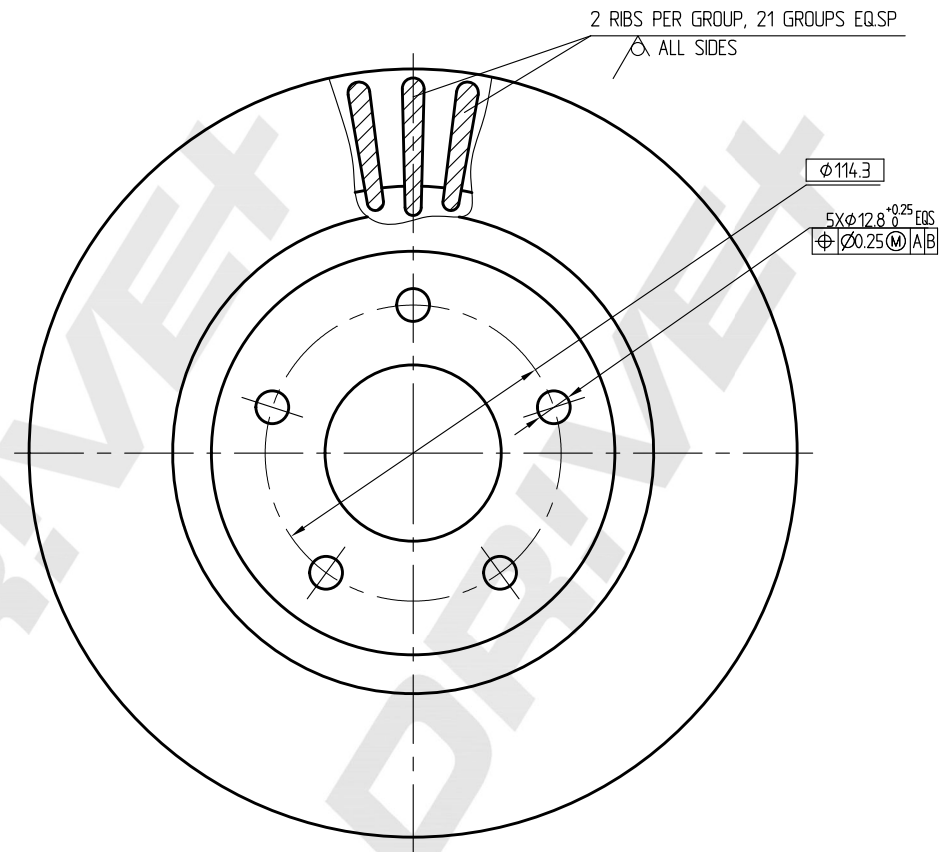

DP Number	Part Number	Drawing Version Number	Drawing Issue Date
DP1010.11.1820	DBD1820	V1	2025.04.19

DRIVET