

MIN THK 20 MM

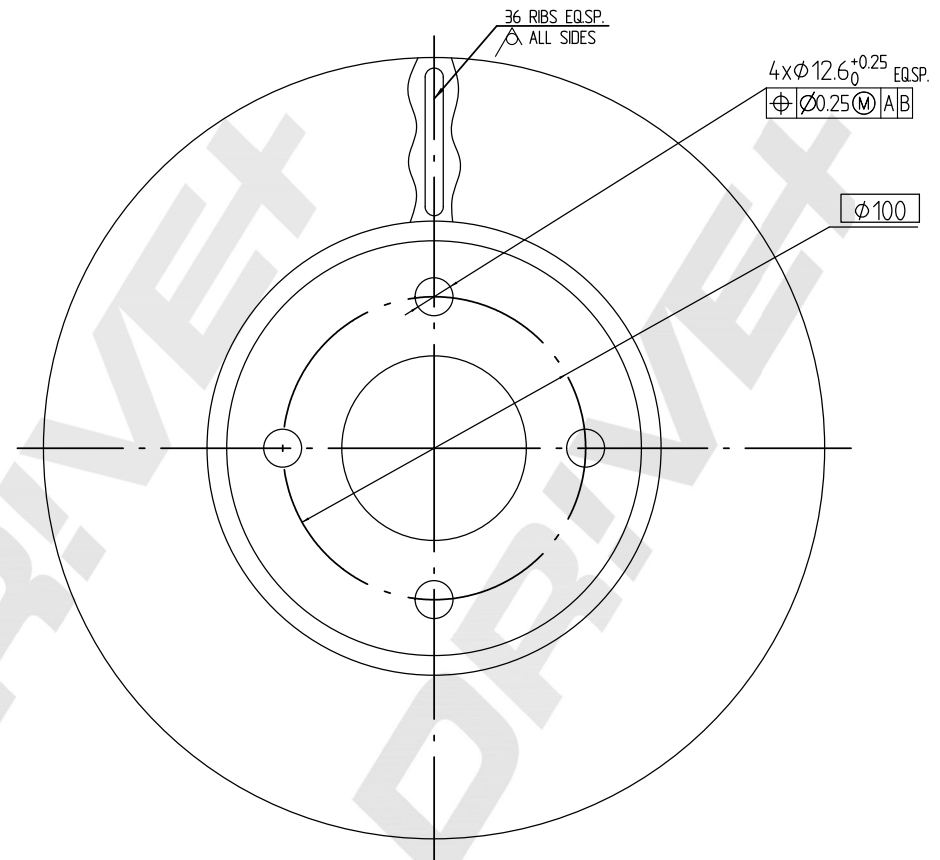

DP Number	Part Number	Drawing Version Number	Drawing Issue Date
DP1010.11.1821	DBD1821	V1	2025.04.19

DRIVET