

MIN THK 16 MM

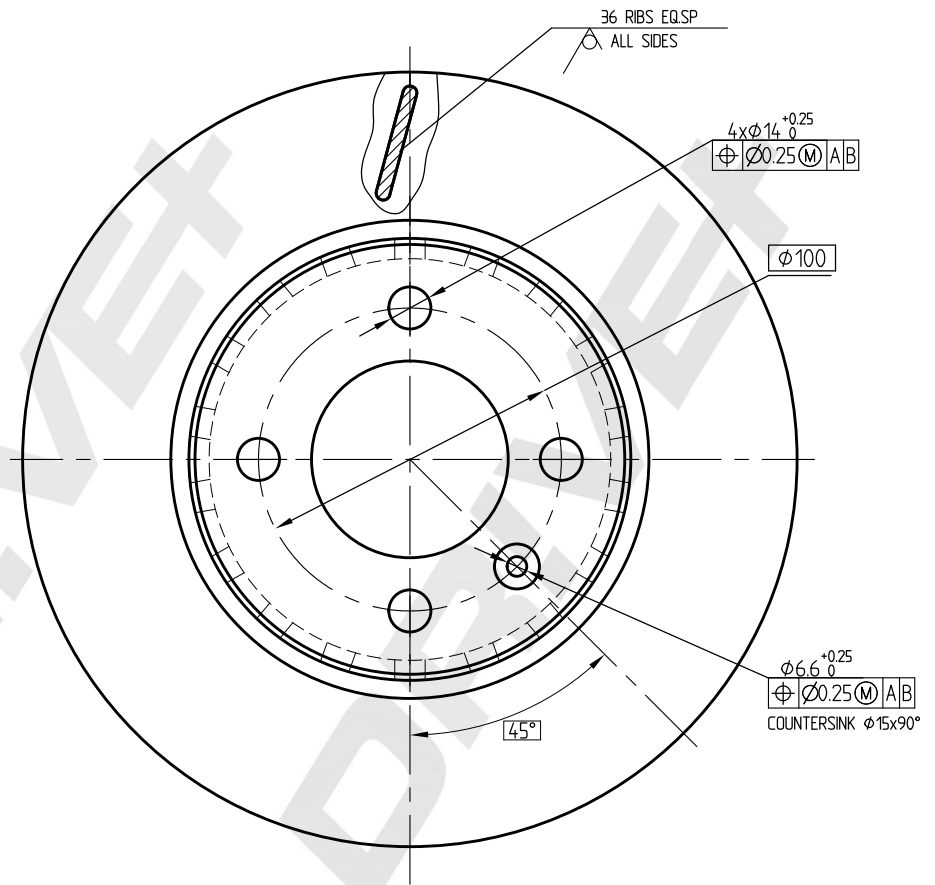

DP Number	Part Number	Drawing Version Number	Drawing Issue Date
DP1010.11.1861	DBD1861	V1	2025.04.19

